

DVD AUDIO/VIDEO SA-CD PLAYER
LECTEUR DE DVD AUDIO/VIDEO SA-CD

DVD-S2500

*OWNER'S MANUAL
MODE D'EMPLOI*

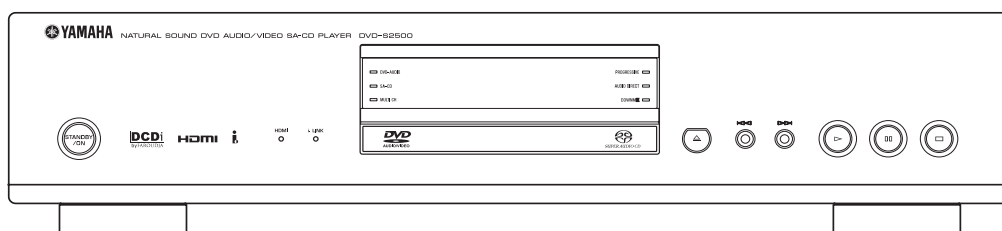

IMPORTANT SAFETY INSTRUCTIONS

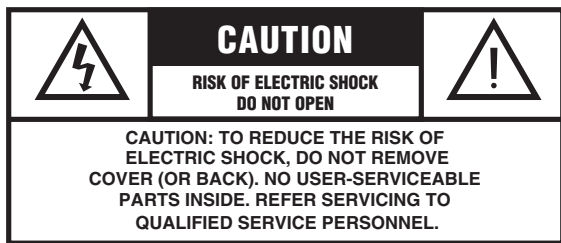

• Explanation of Graphical Symbols



The lightning flash with arrowhead symbol, within an equilateral triangle, is intended to alert you to the presence of uninsulated “dangerous voltage” within the product’s enclosure that may be of sufficient magnitude to constitute a risk of electric shock to persons.



The exclamation point within an equilateral triangle is intended to alert you to the presence of important operating and maintenance (servicing) instructions in the literature accompanying the appliance.

- 1 Read Instructions** — All the safety and operating instructions should be read before the product is operated.
- 2 Retain Instructions** — The safety and operating instructions should be retained for future reference.
- 3 Heed Warnings** — All warnings on the product and in the operating instructions should be adhered to.
- 4 Follow Instructions** — All operating and use instructions should be followed.
- 5 Cleaning** — Unplug this product from the wall outlet before cleaning. Do not use liquid cleaners or aerosol cleaners. Use a damp cloth for cleaning.
- 6 Attachments** — Do not use attachments not recommended by the product manufacturer as they may cause hazards.
- 7 Water and Moisture** — Do not use this product near water — for example, near a bath tub, wash bowl, kitchen sink, or laundry tub; in a wet basement; or near a swimming pool; and the like.
- 8 Accessories** — Do not place this product on an unstable cart, stand, tripod, bracket, or table. The product may fall, causing serious injury to a child or adult, and serious damage to the product. Use only with a cart, stand, tripod, bracket, or table recommended by the manufacturer, or sold with the product. Any mounting of the product should follow the manufacturer’s instructions, and should use a mounting accessory recommended by the manufacturer.
- 9 A product and cart combination should be moved with care.** Quick stops, excessive force, and uneven surfaces may cause the product and cart combination to overturn. 
- 10 Ventilation** — Slots and openings in the cabinet are provided for ventilation and to ensure reliable operation of the product and to protect it from overheating, and these openings must not be blocked or covered. The openings should never be blocked by placing the product on a bed, sofa, rug, or other similar surface. This product should not be placed in a built-in installation such as a bookcase or rack unless proper ventilation is provided or the manufacturer’s instructions have been adhered to.
- 11 Power Sources** — This product should be operated only from the type of power source indicated on the marking label. If you are not sure of the type of power supply to your home, consult your product dealer or local power company. For products intended to operate from battery power, or other sources, refer to the operating instructions.

- 12 Grounding or Polarization** — This product may be equipped with a polarized alternating current line plug (a plug having one blade wider than the other). This plug will fit into the power outlet only one way. This is a safety feature. If you are unable to insert the plug fully into the outlet, try reversing the plug. If the plug should still fail to fit, contact your electrician to replace your obsolete outlet. Do not defeat the safety purpose of the polarized plug.
- 13 Power-Cord Protection** — Power-supply cords should be routed so that they are not likely to be walked on or pinched by items placed upon or against them, paying particular attention to cords at plugs, convenience receptacles, and the point where they exit from the product.
- 14 Lightning** — For added protection for this product during a lightning storm, or when it is left unattended and unused for long periods of time, unplug it from the wall outlet and disconnect the antenna or cable system. This will prevent damage to the product due to lightning and power-line surges.
- 15 Power Lines** — An outside antenna system should not be located in the vicinity of overhead power lines or other electric light or power circuits, or where it can fall into such power lines or circuits. When installing an outside antenna system, extreme care should be taken to keep from touching such power lines or circuits as contact with them might be fatal.
- 16 Overloading** — Do not overload wall outlets, extension cords, or integral convenience receptacles as this can result in a risk of fire or electric shock.
- 17 Object and Liquid Entry** — Never push objects of any kind into this product through openings as they may touch dangerous voltage points or short-out parts that could result in a fire or electric shock. Never spill liquid of any kind on the product.
- 18 Servicing** — Do not attempt to service this product yourself as opening or removing covers may expose you to dangerous voltage or other hazards. Refer all servicing to qualified service personnel.
- 19 Damage Requiring Service** — Unplug this product from the wall outlet and refer servicing to qualified service personnel under the following conditions:
 - a) When the power-supply cord or plug is damaged,**
 - b) If liquid has been spilled, or objects have fallen into the product,**
 - c) If the product has been exposed to rain or water,**
 - d) If the product does not operate normally by following the operating instructions. Adjust only those controls that are covered by the operating instructions as an improper adjustment of other controls may result in damage and will often require extensive work by a qualified technician to restore the product to its normal operation,**
 - e) If the product has been dropped or damaged in any way, and**
 - f) When the product exhibits a distinct change in performance - this indicates a need for service.**
- 20 Replacement Parts** — When replacement parts are required, be sure the service technician has used replacement parts specified by the manufacturer or have the same characteristics as the original part. Unauthorized substitutions may result in fire, electric shock, or other hazards.
- 21 Safety Check** — Upon completion of any service or repairs to this product, ask the service technician to perform safety checks to determine that the product is in proper operating condition.
- 22 Wall or Ceiling Mounting** — The unit should be mounted to a wall or ceiling only as recommended by the manufacturer.
- 23 Heat** — The product should be situated away from heat sources such as radiators, heat registers, stoves, or other products (including amplifiers) that produce heat.

FCC INFORMATION (for US customers)

1. IMPORTANT NOTICE: DO NOT MODIFY THIS UNIT!

This product, when installed as indicated in the instructions contained in this manual, meets FCC requirements. Modifications not expressly approved by Yamaha may void your authority, granted by the FCC, to use the product.

2. IMPORTANT: When connecting this product to accessories and/or another product use only high quality shielded cables. Cable/s supplied with this product MUST be used. Follow all installation instructions. Failure to follow instructions could void your FCC authorization to use this product in the USA.

3. NOTE: This product has been tested and found to comply with the requirements listed in FCC Regulations, Part 15 for Class "B" digital devices.

Compliance with these requirements provides a reasonable level of assurance that your use of this product in a residential environment will not result in harmful interference with other electronic devices. This equipment generates/uses radio frequencies and, if not installed and used according to the instructions found in the users manual, may cause interference harmful to the operation of other electronic devices. Compliance with FCC regulations does not guarantee that interference will not occur in all installations. If this product is found to be the source of interference, which can be determined by turning the product "OFF" and "ON", please try to eliminate the problem by using one of the following measures:

Relocate either this product or the device that is being affected by the interference.

Utilize power outlets that are on different branch (circuit breaker or fuse) circuits or install AC line filter/s.

In the case of radio or TV interference, relocate/reorient the antenna. If the antenna lead-in is 300 ohm ribbon lead, change the lead-in to coaxial type cable.

If these corrective measures do not produce satisfactory results, please contact the local retailer authorized to distribute this type of product. If you can not locate the appropriate retailer, please contact Yamaha Electronics Corp., 6660 Orangethorpe Ave. Buena Park, CA90622.

The above statements apply ONLY to those products distributed by Yamaha Corporation of America or its subsidiaries.

We Want You Listening For A Lifetime

YAMAHA and the Electronic Industries Association's Consumer Electronics Group want you to get the most out of your equipment by playing it at a safe level. One that lets the sound come through loud and clear without annoying blaring or distortion - and, most importantly, without affecting your sensitive hearing.

Since hearing damage from loud sounds is often undetectable until it is too late, YAMAHA and the Electronic Industries Association's Consumer Electronics Group recommend you to avoid prolonged exposure from excessive volume levels.



CAUTION - Visible and invisible laser radiation when open. Avoid exposure to beam.

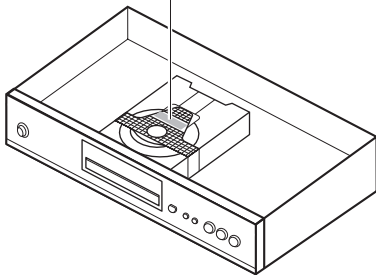

CLASS 1 LASER PRODUCT
LASER KLASSE 1 PRODUKT
LUOKAN 1 LASERLAITE
KLASS 1 LASER APPARAT
PRODUIT LASER DE CLASSE 1

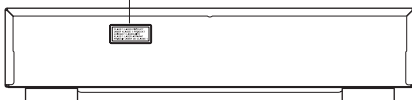

For Customer Use:

Read carefully the information located at the rear panel of the player and enter below the Serial No. Retain this information for future reference.

Model No. _____

Serial No. _____

FOR CANADIAN CUSTOMERS

To prevent electric shock, match wide blade of plug to wide slot and fully insert.

This Class B digital apparatus complies with Canadian ICES-003.

This digital apparatus does not exceed the Class B limits for radio noise emissions from digital apparatus as set out in the Radio Interference Regulations of the Canadian Department of Communications.

POUR LES CONSOMMATEURS CANADIENS

Pour éviter les chocs électriques, introduire la lame la plus large de la fiche dans la borne correspondante de la prise et pousser jusqu'au fond.

Cet appareil numérique de la classe B est conforme à la norme NMB-003 du Canada.

CAUTION

Use of controls or adjustments or performance of procedures other than those specified herein may result in hazardous radiation exposure.

CAUTION: READ THIS BEFORE OPERATING YOUR UNIT

- 1 To assure the finest performance, please read this manual carefully. Keep it in a safe place for future reference.
- 2 Install this sound system in a well ventilated, cool, dry, clean place — away from direct sunlight, heat sources, vibration, dust, moisture, or cold. In a cabinet, allow about 2.5cm (1 inch) of free space all around this unit for adequate ventilation.
- 3 Locate this unit away from other electrical appliances, motors, or transformers to avoid humming sounds.
- 4 Do not expose this unit to sudden temperature changes from cold to hot, nor locate this unit in an environment with high humidity (i.e., a room with a humidifier) to prevent condensation inside this unit, which may cause an electrical shock, fire, damage to this unit, and/or personal injury.
- 5 Avoid installing this unit in a location where foreign objects may fall onto this unit or where this unit may be exposed to liquid dripping or splashing. On the top of this unit, do not place:
 - Other components, as they may cause damage and/or discoloration on the surface of this unit.
 - Burning objects (i.e., candles), as they may cause fire, damage to this unit, and/or personal injury.
 - Containers with liquid in them, as they may fall, spilling the liquid and causing an electrical shock to the user and/or damage to this unit.
- 6 Do not cover this unit with a newspaper, tablecloth, curtain, etc. in order not to obstruct heat radiation. If the temperature inside this unit rises, it may cause fire, damage to this unit, and/or personal injury.
- 7 Do not plug in this unit to a wall outlet until all connections are complete.
- 8 Do not operate this unit upside-down. It may overheat, possibly causing damage.
- 9 Do not use excessive force on switches, knobs and/or cords.
- 10 When disconnecting the power cord from the wall outlet, grasp the plug; do not pull the cord.
- 11 Do not clean this unit with chemical solvents; this might damage the finish. Use a clean, dry cloth.
- 12 Use only the voltage specified on this unit. Using this unit with a higher voltage than specified is dangerous and may cause fire, damage to this unit, and/or personal injury. YAMAHA will not be held responsible for any damage resulting from use of this unit with a voltage other than as specified.
- 13 To prevent damage by lightning, disconnect the power cord from the wall outlet during an electrical storm.
- 14 Do not attempt to modify or fix this unit. Contact qualified YAMAHA service personnel when any service is needed. The cabinet should never be opened for any reason.
- 15 When not planning to use this unit for long periods of time (i.e., vacation), disconnect the AC power plug from the wall outlet.
- 16 Be sure to read the “TROUBLESHOOTING” section on common operating errors before concluding that this unit is faulty.
- 17 Before moving this unit, press STANDBY/ON to set the unit in standby mode, then disconnect the AC power plug from the wall outlet.
- 18 Place this unit on a flat, hard and stable surface.
- 19 There must be sufficient room in front of the player for the disc tray to be opened.
- 20 The mechanical parts of the set contain self-lubricating bearings and must not be oiled or lubricated.

The unit is not disconnected from the AC power source as long as it is connected to the wall outlet, even if this unit itself is turned off. This state is called the standby mode. In this state, this unit is designed to consume a very small quantity of power.

WARNING

TO REDUCE THE RISK OF FIRE OR ELECTRIC SHOCK, DO NOT EXPOSE THIS UNIT TO RAIN OR MOISTURE.

NOTE:

Pictures shown maybe different between countries. Never make or change connections with the power switched on.

When playing DTS encoded CDs, excessive noise will be heard from the analog stereo outputs. To avoid possible damage to the audio system, the consumer should take proper precautions when the analog stereo outputs of the player are connected to an amplification system. To enjoy DTS Digital Surround™ playback, an external 5.1-channel DTS Digital Surround™ decoder system must be connected to the digital output of the player.

LASER SAFETY

This unit employs a laser. Due to possible eye injury, only a qualified service person should remove the cover or attempt to service this device.

CAUTION

VISIBLE AND INVISIBLE LASER RADIATION WHEN OPEN. AVOID EXPOSURE TO BEAM.

LASER DIODE PROPERTIES

Type	Semiconductor laser GaAlAs
Wave length	650 nm (DVD/SA-CD) 790 nm (VCD/CD)
Output Power	7 mW (DVD/SA-CD/VCD/CD)

DANGER

This unit emits visible laser radiation when open. Avoid direct eye exposure to beam. When this unit is plugged into a wall outlet, do not place your eyes close to the opening of the disc tray and other openings or look inside.

Table of Contents

Introduction 2

Patent information.....	2
Playable disc formats.....	2
Region management information.....	3
Supplied accessories.....	3
Installing batteries in the remote control.....	3
Using the remote control.....	4
Maintenance.....	4

Functional Overview 5

Front panel.....	5
Rear panel.....	6
Remote control connectors and RS-232C terminal.....	6
Remote control.....	7

Preparation 8

Audio connection.....	8
Digital audio connections.....	8
i.LINK components connections.....	8
Analog audio (6CH DISCRETE) connection.....	8
Analog audio (MIXED 2CH) connection.....	9
Video connections.....	9
HDMI component connections.....	9
Switching on.....	10
Setups before the initial playback.....	10

On-screen menu 12

General operation.....	12
Preferences.....	12
Features.....	12
Adv.Picture.....	12
Picture.....	13
Sound.....	13
Toolbar.....	14
Program.....	14
View.....	14
Play option.....	14
Search.....	14
Slide Show.....	15
Setup.....	15
Access.....	15
Features.....	15
TV.....	15
Audio Menu.....	16
Language.....	17
Speakers.....	17
DVD/CD Mode.....	18
SA-CD Mode.....	18
i.LINK.....	18

Operation 20

Basic playback.....	20
DVD-Video and DVD-Audio.....	20
Playing a disc.....	20
Smart Resume.....	20

DVD features.....	21
Menu.....	21
Camera angle.....	21
Changing the audio language and format.....	21
Subtitle language.....	21
DVD-Audio features.....	21
Changing pages.....	21
Playing bonus groups.....	21
DVD Video Mode.....	21
SA-CD (Super Audio CD).....	22
Playing a disc.....	22
Sound mode – SA-CD playback.....	22
Audio CD.....	23
Playing a disc.....	23
Video CD and Super Video CD.....	23
Playing a disc.....	23
Playback Control (PBC).....	23
MP3.....	24
MP3 disc features.....	24
Playing a disc.....	24
Choosing an Album/Track to playback.....	24
MP3 text.....	24
JPEG.....	25
JPEG disc features.....	25
Playing a disc.....	25
Slide show setting.....	25
Rotating the image.....	25
General features.....	26
Moving to another segment.....	26
Search.....	26
Slow motion.....	26
Still picture and frame-by-frame playback.....	26
Time search.....	26
Repeat.....	27
Repeat A-B.....	27
Shuffle.....	27
Scan.....	27
Zoom.....	27
FTS video/audio program.....	28
Activating/deactivating the FTS program.....	28
Erasing a track/chapter/index from the FTS list.....	28
Erasing all tracks/chapters/indexes from the FTS list.....	28
Disc lock.....	28
Activating/deactivating Disc lock.....	28
Authorizing discs.....	28
Deauthorizing discs.....	29
Parental Control.....	29
Activating/deactivating Parental Control.....	29
Country.....	29
Changing the four-digit PIN.....	29
If you forget your four-digit code.....	29

Troubleshooting 30

Specifications 31

Introduction

Thank you for purchasing the YAMAHA DVD AUDIO/VIDEO SA-CD player. This Owner's Manual explains its basic operations.

Patent information



Manufactured under license from Dolby Laboratories. "Dolby", "Pro Logic", and the double-D symbol are trademarks of Dolby Laboratories.



"DTS" and "DTS Digital Surround" are registered trademarks of Digital Theater Systems, Inc.



"DCDi" is a trademark of Faroudja, a division of Genesis Microchip, Inc.



HDMI, the HDMI logo and High-Definition Multimedia Interface are trademarks or registered trademark of HDMI Licensing LLC.

This product incorporates copyright protection technology that is protected by method claims of certain U.S. patents and other intellectual property rights owned by Macrovision Corporation and other rights owners. Use of this copyright protection technology must be authorized by Macrovision Corporation, and is intended for home and other limited viewing uses only unless otherwise authorized by Macrovision Corporation. Reverse engineering or disassembly is prohibited.

"i.LINK" and the "i.LINK" logo  are trademarks of Sony Corporation.

This product complies with the following i.LINK interface specifications:

1. IEEE Std 1394a-2000, Standard for a High Performance Serial Bus
2. Audio and Music Data Transmission Protocol 2.1

Following the standard for AM824 sequence adaptation layers, the product is compatible with IEC60958 bitstream, DVD-A and SA-CD media.



Playable disc formats

This unit can play the disc types associated with the logos shown below. (Do not attempt to load any other type of disc into the unit, or the unit may be damaged.)



This manual refers to disc types using the following symbols:

		
---	--	---

		
---	---	---







*1  icon includes Super Video CD.

Notes:

- This unit is designed for use with SA-CD, DVD-Video, DVD-Audio, Video CD, Super Video CD, Audio CD, CD-R and CD-RW (MP3 and JPEG supported), DVD+R and DVD+RW, DVD-R and DVD-RW.
- CD-R and CD-RW discs cannot be played unless they have been finalized.
- DVD+R and DVD+RW discs cannot be played unless they have been finalized.
- DVD-R and DVD-RW discs must be recorded in Video format and must be finalized.
- Some discs cannot be played depending on disc characteristics or recording conditions.
- Be sure to use only CD-R and CD-RW discs from reliable manufacturers.
- Dolby Digital, DTS Digital Surround, and MPEG digital audio are supported.
- PAL and NTSC are supported.
- This unit features the PAL and NTSC video system converting function to allow you watching the different types of video discs on one TV (see "TV System (NTSC/PAL conversion)" on page 15).
- Do not use any non-standard shaped discs (heart, etc.).
- Do not use discs that have tape, scales, or paste on them or damage to the unit may result.
- Do not use discs with surfaces printed by a commercial label printer.
- Some DVD discs require specific features or allow only limited function during playback.
- Prohibited mark may appear on the TV screen to indicate that a function is unavailable.
- Photo CD, CD-ROM, DVD-ROM, DVD-RAM, CDV and nonstandard CD discs cannot be played on this unit.

Region management information

The unit is designed to support the Region Management System. Check the regional code number on the disc package. If the number does not match the unit's region number (see table below, or see back of unit), the unit may be unable to play the disc.

Model	Region number of the unit	Discs that can be played (Example)
U.S.A. model		 
U.K. and Europe models		 

Supplied accessories

Check your package to make sure it contains the following items:

Remote control

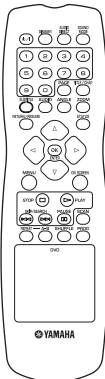

Batteries (x2) (AA, R6, UM-3)

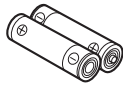

Audio/Video cable

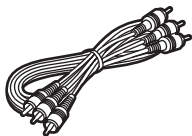

Power cable

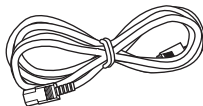

Installing batteries in the remote control

Insert the batteries in the correct direction by aligning the “+” and “-” marks on the batteries with the polarity markings “+” and “-” inside the battery compartment.

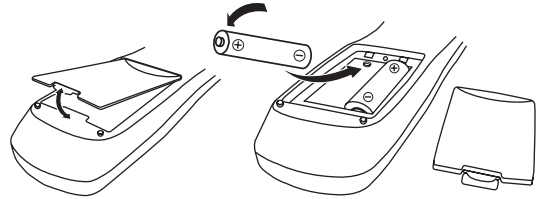

- 1 Remove the back cover.
- 2 Insert the two supplied batteries (AA, R6, UM-3) into the battery compartment.
- 3 Close the back cover.

Replace worn batteries

Worn batteries limit the operating range of the remote control. Replace both batteries at the same time.

- Replace both batteries if you notice a decrease in the operating range of the remote control.
- Do not use old batteries with new ones.
- Do not use different types of batteries (such as alkaline and manganese) together. Read the battery packaging carefully. Different types of batteries may be the same shape or color.
- If the batteries leak, dispose of them immediately. Avoid touching the leaked material or letting it come into contact with clothing, etc. Clean the battery compartment thoroughly before installing new batteries.

Introduction

Using the remote control

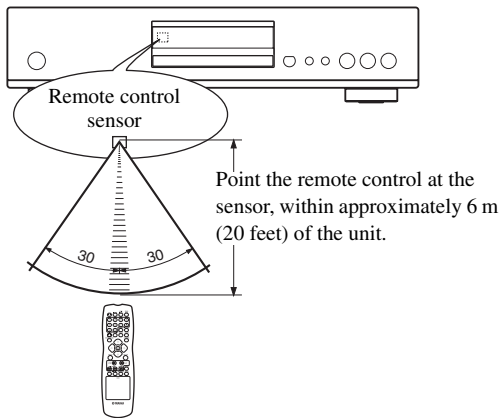

Handling the remote control

- Do not spill water or other liquids on the remote control.
- Do not drop the remote control.
- Do not leave or store the remote control in the following types of conditions:
 - high humidity such as near a bath
 - high temperature such as near a heater or stove
 - extremely low temperature
 - dusty places

Maintenance

Cleaning the cabinet

- Use a soft cloth slightly moistened with a mild detergent solution. Do not use a solution that contains alcohol, spirits, ammonia or abrasives.

Cleaning discs

- When a disc becomes dirty, clean it with a cleaning cloth. Wipe the disc from the center out. Do not wipe in a circular motion.
- Do not use solvents such as benzene, thinner, commercial cleaners, or anti-static spray designed for analog records.

Functional Overview

Front panel

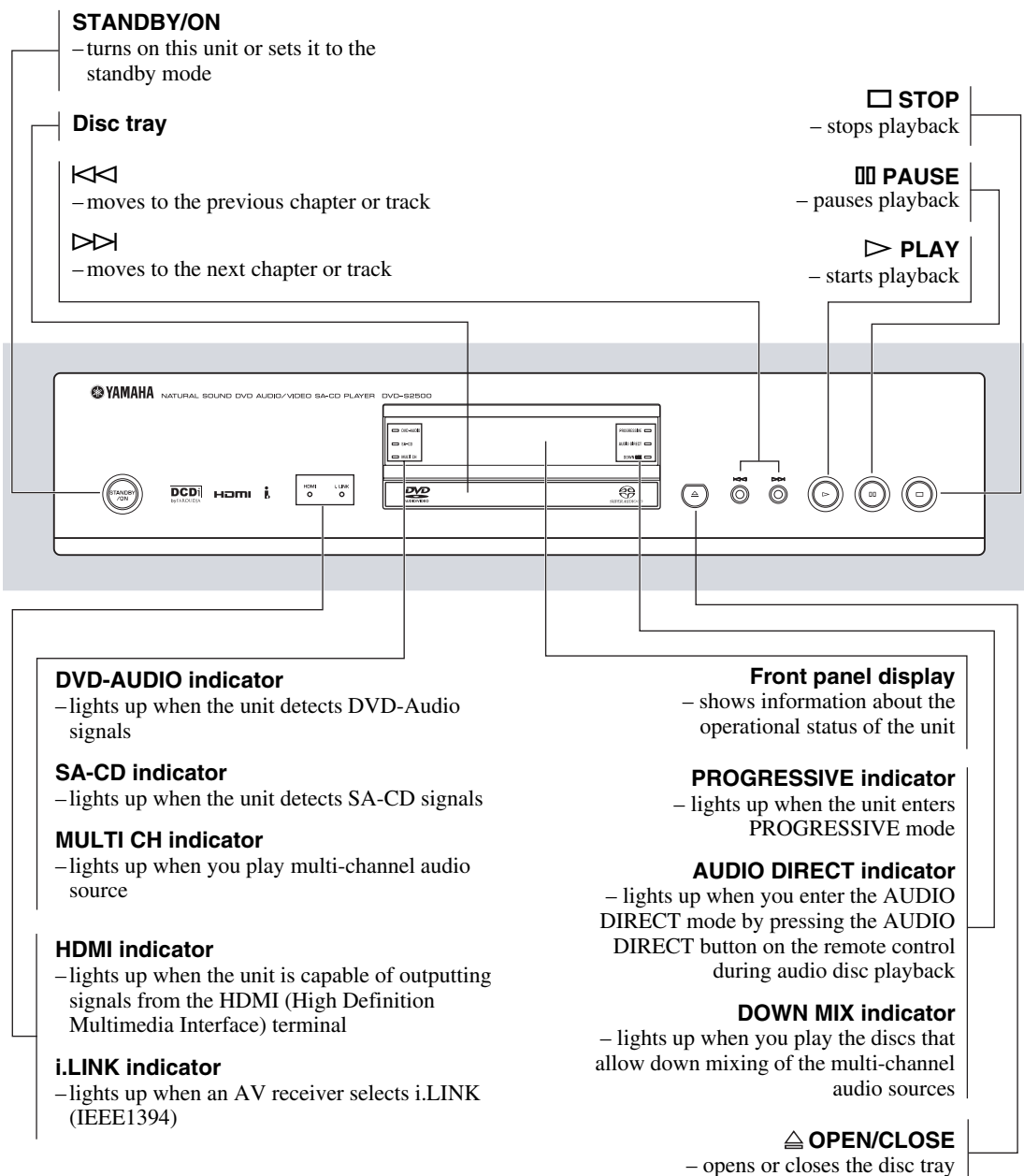

Rear panel

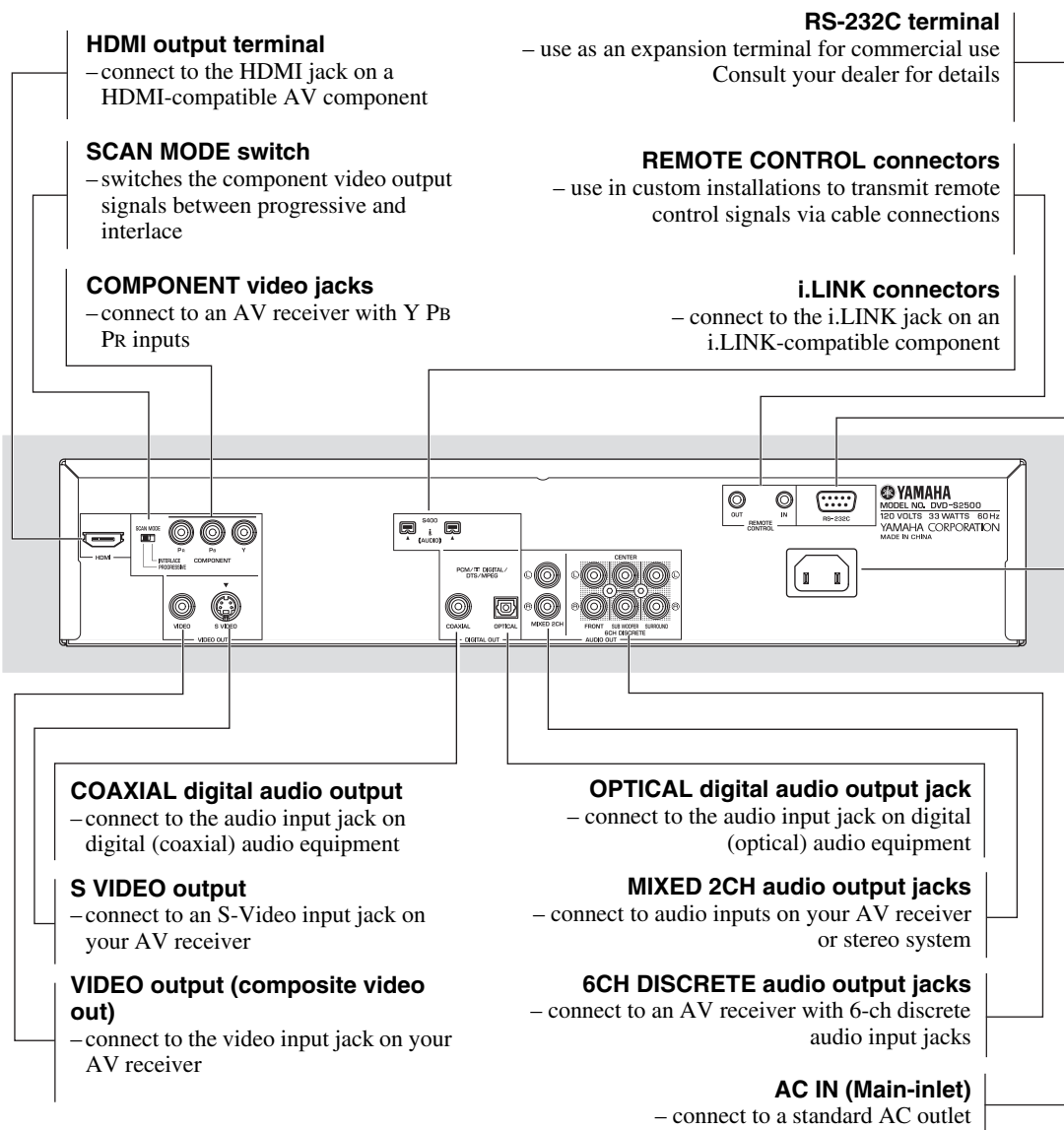

Remote control connectors and RS-232C terminal

Remote control connectors are used in custom installations to transmit remote control signals via cable.

- Connect REMOTE CONTROL IN to an output on your remote control system.
- Connect REMOTE CONTROL OUT to a remote control input on another component to enable system control.

This unit is also equipped with RS-232C terminal. Consult your dealer for details.

Caution: Do not touch the inner pins of the jacks on the rear panel. Electrostatic discharge may cause permanent damage to the unit.

Remote control

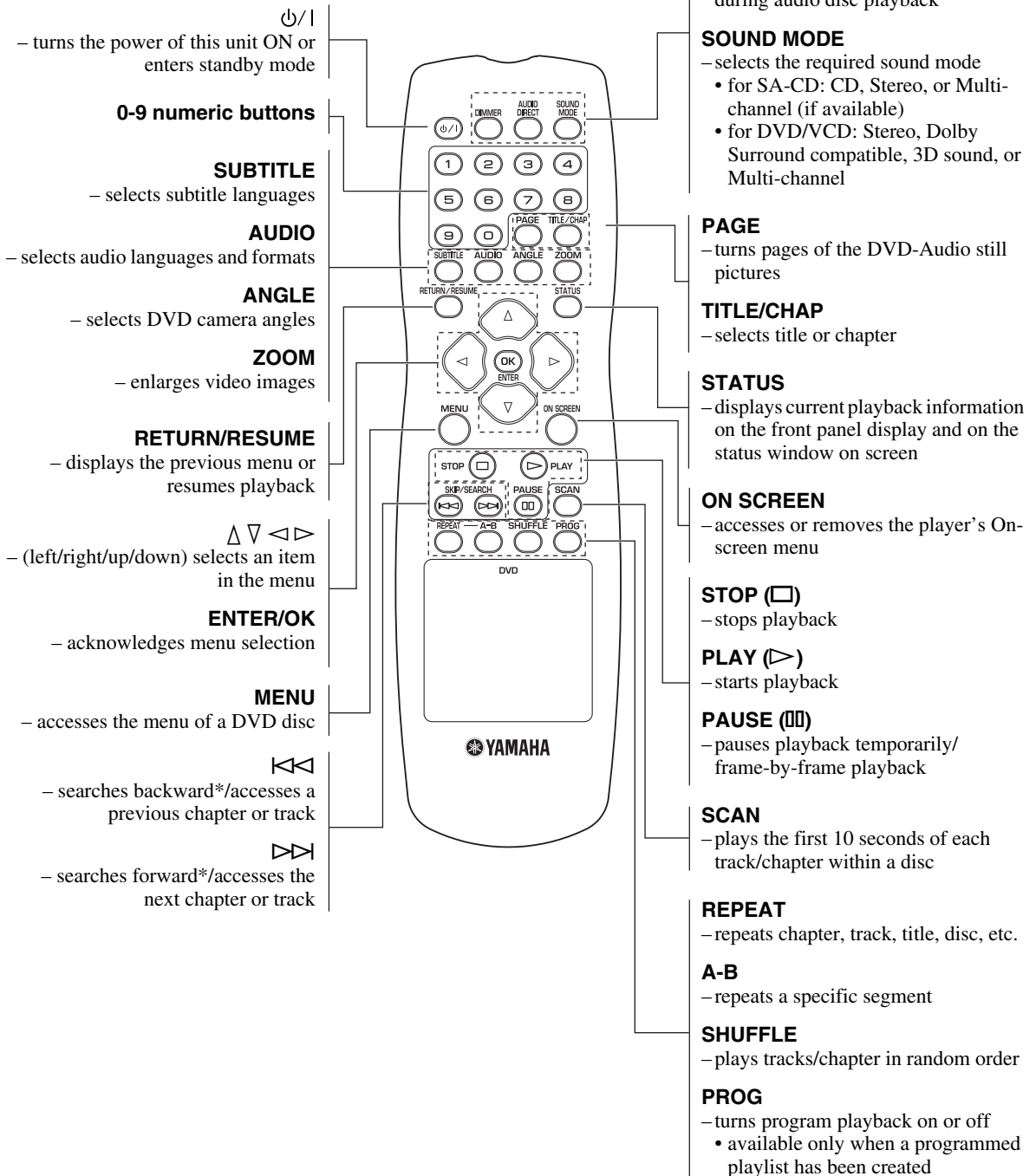

* Press and hold button for about two seconds.

Preparation

- There are various ways to connect the player, depending on the equipment you wish to use. The following drawings illustrate some possible configurations.
- Please refer to manuals for other equipment as necessary to ensure that you make the correct connections.
- Do not connect the player via your VCR. The video quality could be distorted by the copy protection system.
- Do not connect the player's audio output jack to the phono input jack on your audio system.

Audio connection

Digital audio connections

This unit features COAXIAL and OPTICAL digital output jacks. Connect one or both of them to digital input jacks of an AV receiver. You can also enjoy high-quality stereo sound at sampling frequencies of 88.2 and 96 kHz, assuming the material is not copy-protected and the equipment you connect is compatible with these signals.

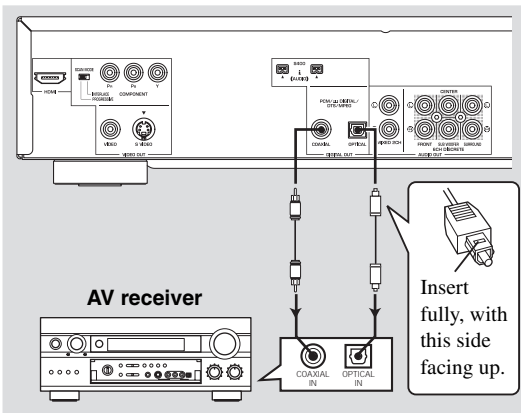

Notes:

- If the audio format of the digital output does not match the capabilities of your receiver, the receiver will produce a strong, distorted sound or no sound at all. Make sure to select the appropriate audio format on the disc menu screen. Pressing AUDIO once or more may change not only the audio language but also the audio format. The selected format name will be displayed for several seconds in the status window.
- SA-CD audio signal is not output from DIGITAL OUT jacks.
- If you wish to enjoy Dolby Digital, DTS, and MPEG you must connect this unit to the AV receiver that support those.

i.LINK components connections

Use an i.LINK connection cable of approximately 3m (10 feet) or less to connect this unit to i.LINK-compatible components (refer to page 18 for details).

Analog audio (6CH DISCRETE) connection

Connect a receiver with multi-channel audio input terminals to enjoy surround sound with no sampling frequency limitation. We recommend this connection to obtain maximum performance of SA-CD discs and DVD-Audio multi-channel sound.

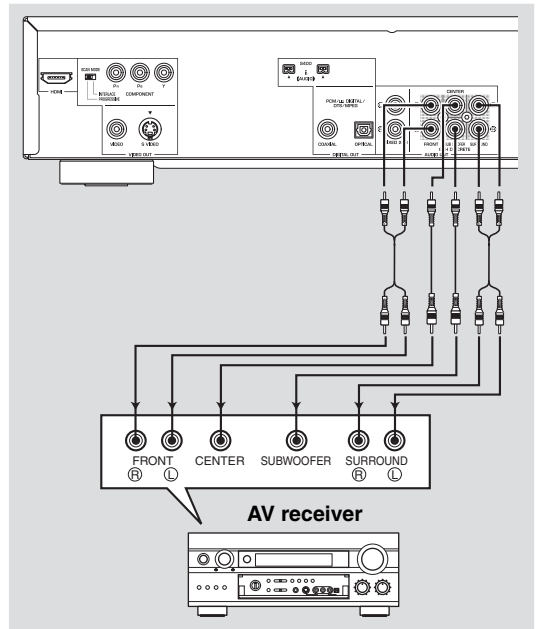

Analog audio (MIXED 2CH) connection

Use the audio cable supplied with the player to connect AUDIO OUT L (left) and R (right) jacks of the player to the corresponding input jacks on your audio equipment, such as an AV receiver.

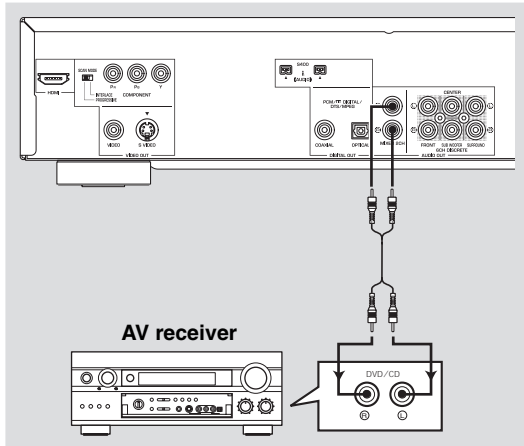

Video connections

If your AV receiver features video output jacks, connect this unit to the AV receiver (and then to your TV). This enables you to use one TV for several different video sources (LD, VCR etc.) by simply switching the input source selector on your AV receiver.

This unit features three types of video output jacks (Component, Video and S-Video). Connect the appropriate video output jack to your equipment.

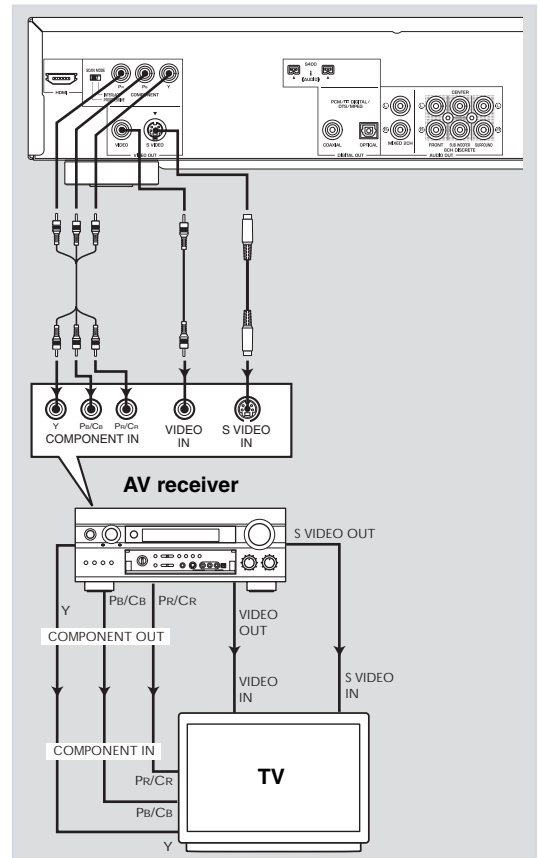

HDMI component connections

Use the HDMI connection cable to connect this unit to HDMI-compatible components.

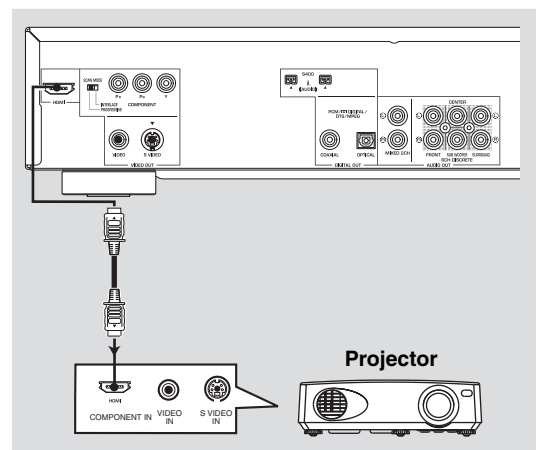

Note:

- You can use a HDMI to DVI conversion cable to connect this unit to DVI HDCP compatible components. In this case, no audio signals are output from this unit's jacks.

Preparation

SCAN MODE selector

This selector switches the type of output signal from the COMPONENT video jacks on this unit.

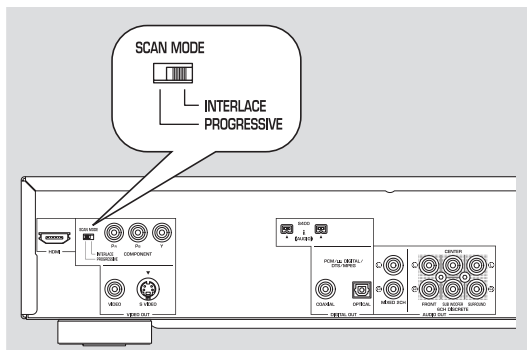

INTERLACE:

Select INTERLACE if you are connecting the component to a standard (interlace format) TV.

PROGRESSIVE:

Select PROGRESSIVE if your TV accepts NTSC progressive or PAL progressive signals. This setting will enable you to enjoy accurate color reproduction and high quality images. This unit features DCDi circuit. The PROGRESSIVE indicator on the front panel lights up during progressive playback.

Notes:

- In the PROGRESSIVE mode, 4:3 aspect images are stretched horizontally on the wide screen TV. We recommend to change the TV screen's aspect ratio settings for progressive signals if you wish to watch the original aspect ratio images without distortion. You can also change the aspect ratio settings in the [4:3 Aspect] parameter in the On-screen menu.
- Some TVs and projectors are not compatible with this unit. If you notice picture distortion when outputting the progressive signals, switch the SCAN MODE selector to INTERLACE.

CONSUMERS SHOULD NOTE THAT NOT ALL HIGH DEFINITION TELEVISION SETS ARE FULLY COMPATIBLE WITH THIS PRODUCT AND MAY CAUSE ARTIFACTS TO BE DISPLAYED IN THE PICTURE. IN CASE OF 525 OR 625 PROGRESSIVE SCAN PICTURE PROBLEMS, IT IS RECOMMENDED THAT THE USER SWITCH THE CONNECTION TO THE "STANDARD DEFINITION" OUTPUT. IF THERE ARE QUESTIONS REGARDING OUR VIDEO MONITOR COMPATIBILITY WITH THIS MODEL 525P AND 625P DVD PLAYER, PLEASE CONTACT OUR CUSTOMER SERVICE CENTER.

This unit is compatible with the complete line of YAMAHA products, including the projectors DPX-1000, DPX-1100, LPX-500, LPX-510, the plasma monitor PDM-1 and PDM-4210.

Switching on

- 1 Connect the AC power cord to the power outlet.
- 2 Switch on the TV and this unit.
- 3 Set the TV to the correct Video IN channel. (e.g. EXT1, EXT2, AV1, AV2, AUDIO/VIDEO, etc. Refer to your TV owner's manual for detail.)
 - The front panel display lights up and the default screen appears on the TV.
- 4 If you are using an external equipment (e.g. audio system or receiver), turn them on and select the appropriate input source that was used to connect to this unit. Refer to the equipment owner's manual for detail.

Note:

- If you do not have a proper picture or sound, refer to "Troubleshooting" section.

Setups before the initial playback

We recommend to setup some of the basic menu items before the initial playback.

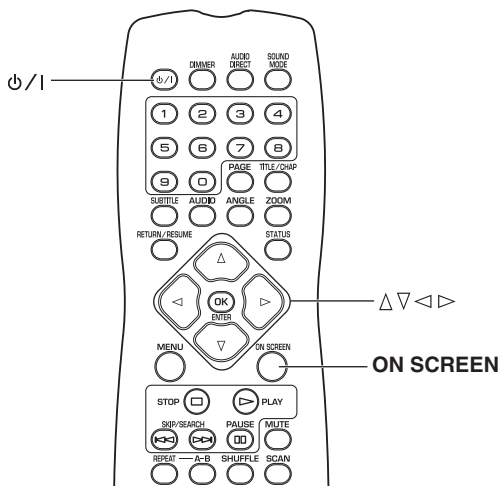

- 1 Press STANDBY/ON ϕ/I to turn on the unit.
- 2 Press ON SCREEN.
 - On-screen menu is displayed on the screen.
- 3 Follow the procedure described below to set the following menu items.

① Menu Language (see page 17)

You can select the language displayed in the On-screen menu.

- 1 Go to [Menu Language] (Setup → Language → Menu Language) by using Δ ∇ \triangleleft \triangleright buttons on the remote control, then press \triangleright .
→ Choices are displayed on the right column.
- 2 Select a language to be displayed in the On-screen menu by using Δ ∇ buttons.
- 3 Press \triangleleft to return to the previous menu.

② Default Audio (see page 17)

You can select the audio language spoken in video discs. Available choices are determined by the disc.

- 1 Go to [Default Audio] (Setup → Language → Default Audio) by using Δ ∇ \triangleleft \triangleright buttons on the remote control, then press \triangleright .
→ Choices are displayed on the right column.
- 2 Select a language by using Δ ∇ buttons.
- 3 Press \triangleleft to return to the previous menu.

③ Default Sub-title (see page 17)

You can select the subtitle language set as default. Available choices are determined by the disc.

- 1 Go to [Default Sub-title] (Setup → Language → Default sub-title) by using Δ ∇ \triangleleft \triangleright buttons on the remote control, then press \triangleright .
→ Choices are displayed on the right column.
- 2 Select a default subtitle language by using Δ ∇ buttons.
- 3 Press \triangleleft to return to the previous menu.

④ TV shape (see page 15)

You can select the aspect ratio of the video displayed on the TV monitor.

Select [Widescreen] if you connect to a wide-screen monitor. If you connect to a conventional monitor, select [4:3 panscan] (the left and right sides are trimmed when you play 16:9 video) or [4:3 letterbox] (black areas appear at the top and bottom when you play 16:9 video).

- 1 Go to [TV shape] (Setup → TV → TV shape) by using Δ ∇ \triangleleft \triangleright buttons on the remote control, then press \triangleright .
→ Choices are displayed on the right column.
- 2 Make a choice by using Δ ∇ buttons.
- 3 Press \triangleleft to return to the previous menu.

⑤ Analog output (see page 16)

Enables you to specify the type of analog output suitable for your AV receiver. Select [Multi-channel] if you are using a multi-channel AV receiver with 6-ch discrete inputs. If your AV receiver does not have 6-ch discrete inputs, select one of [Stereo], [Dolby Surr Compat], or [3D sound].

- 1 Go to [Analog output] (Setup → Audio Menu → Analog output) by using Δ ∇ \triangleleft \triangleright buttons on the remote control, then press \triangleright .
→ Choices are displayed on the right column.
- 2 Select an item for the analog output signal by using Δ ∇ buttons.
- 3 Press \triangleleft to return to the previous menu.

⑥ Digital output (see page 16)

Enables you to specify the type of digital output suitable for your AV receiver. Select [PCM only] if your AV receiver is not capable of decoding multi-channel audio. Select [All] if you connected this unit's digital out jacks to a multi-channel AV receiver.

- 1 Go to [Digital output] (Setup → Audio Menu → Digital output) by using Δ ∇ \triangleleft \triangleright buttons on the remote control, then press \triangleright .
→ Choices are displayed on the right column.
- 2 Select an item for the digital output signal by using Δ ∇ buttons.
- 3 Press \triangleleft to return to the previous menu.

Notes:

- Press ON SCREEN again to exit from the On-screen menu.
- You can find the selection of the helpful menu items in [Preference] and [Setup].
Go to [Preference] if you want to customize this unit for your personal requirement such as the Wake-up timer.
Go to [Setup] if you want to set the operational status of this unit.

On-screen menu

The On-screen menu enables you to customize this unit to suit your requirements.

General operation

- 1 Press ON SCREEN on the remote control.
→ The On-screen menu appears on the screen.

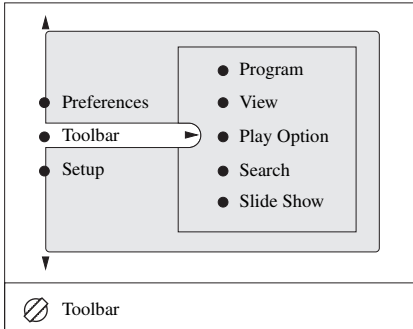

- 2 Press Δ ∇ \triangleleft \triangleright to navigate the On-screen menu and to change the settings.
- 3 Press ON SCREEN to exit from the On-screen menu.

Preferences

Features

Dimmer

Adjusts the brightness of the front panel display. You can use this function if the brightness of the front panel display disturbs your enjoyment of the home theater.

Choices: Low, Medium, Normal
Initial setting: Normal

Wake up timer

Turns on the player from standby mode after a preset amount of time. The timer is then reset to zero. You can set the timer for up to 600 minutes.

Choices: 0 to 600 minutes
Initial setting: 0

Status window

Displays the current status of the player. Select [Off] to suppress display of the Status window.

Choices: On, Off
Initial setting: On

Adv.Picture

Allows you to fine-tune the following video parameters.

4:3 Aspect

You can adjust the aspect ratio of the projected images on the screen. This function is only available for progressive scan and HDMI video output.

Select [NL_Stretch] for display of 4:3 image on the 16:9 screen with non-linear stretching (Center position of screen is stretch less than the side).

Select [4:3 PillarBox] to display 4:3 image on the 16:9 screen without stretching. Even when playing a disc recorded in the 16:9 squeeze mode, the picture is displayed in the center of the screen.

No aspect ratio adjustment is made when [Auto] is selected.

We recommend setting the aspect ratio on your TV if the function is available.

Choices: 4:3 PillarBox, NL_Stretch, Auto
Initial setting: Auto

TrueLife

Produces more dynamic picture by increasing the picture contrast and the color intensity. This function is available for progressive scan output only.

Choices: 0 to +7
Initial setting: 0

DCDi

DCDi (Directional Correction Deinterlacing) computes and tracks the angle of the screen edge to fill in the missing pixel on the TV screen. DCDi will optimize the image quality significantly, especially during the slow motion playback. This function is available for progressive scan output only.

Choices: On, Off
Initial setting: On

Chroma Delay

The chroma (color) and luminance (brightness) signals are not synchronized. The Chroma Delay setting allows you to adjust the advance delay of the chroma signal to yield a perfectly clear picture. This function is available for signals output from COMPONENT video jacks only.

Choices: -3 to +3
Initial setting: 0

Gamma

Enables you to adjust the intensity of the picture non-linearly. A positive value enables you to bring out low level detail in dark scenes, while a negative value emphasizes contrast. This function is available for signals output from COMPONENT video jacks only.

Choices: -7 to +7
Initial setting: 0

HDMI Video

Enables you to adjust the resolution depending on the monitor you are using. You can use this function only when the HDMI output terminal is connected to a HDMI-compatible component.

Choices: 480p, 576p, 720p, 1080i, Auto
Initial setting: 480p

Setting Examples

HDMI Video	Functions
480p	Select the desired resolution for the monitor you are using. *1
576p	
720p	
1080i	
Auto	The resolution is automatically selected to match the monitor you are using.

Monitor shape	Playback disc	TV shape	4:3 aspect
16:9 (Projector)	Squeezed 16:9 video	Widescreen	Auto
	4:3 video	Widescreen	4:3 PillarBox *2
4:3	Squeezed 16:9 video	4:3 panscan or 4:3 letterbox	—
	4:3 video	4:3 panscan or 4:3 letterbox	—

*: Refer to the instruction manual of the monitor and choose an appropriate aspect ratio.

*1: The HDMI video output may not be displayed properly if the HDMI-compatible monitor you are using does not support the selected resolution setting.

To return to the initial setting, you must first stop playback and eject the disc, then press “PLAY” → “0” → “2” → “9” → “STOP” on the remote control.

*2: If the desired aspect ratio is not available, select the most suitable setting from [AUTO], [4:3 PillarBox] and [NL_Stretch].

Notes:

- While HDMI video signals are being output, component video output is unavailable.
- When a video setting is modified, the picture may not be displayed for several seconds.
- When the image conversion (PAL ↔ NTSC) begins, the picture may not be displayed for several seconds.

Picture

Video shift

Adjusts the position of the image on the screen by scrolling it to the left or right.

Choices: +1 to +7
Initial setting: +4

Saturation

Adjusts the video color saturation. This function is not available for signals output from COMPONENT video jacks and HDMI video signals.

Choices: -7 to +7
Initial setting: 0

Contrast

Accentuates bright and dark parts of the video. This function is not available for signals output from COMPONENT video jacks and HDMI video signals.

Choices: -7 to +7
Initial setting: 0

Picture Mode

Adjusts the color tone to suit your preference and the playing source. [Personal] will be chosen automatically when you change the value in the following menus: [Saturation], [Contrast], [Brightness], and [Sharpness]. This function is not available for signals output from COMPONENT video jacks and HDMI video signals.

Choices: Rich, Natural, Soft, Animation, Personal
Initial setting: Natural

Brightness

Adjusts the overall brightness of the picture. This function is not available for signals output from COMPONENT video jacks and HDMI video signals.

Choices: -7 to +7
Initial setting: 0

Sharpness

Adjusts the sharpness of the video.

Choices: 0 to +7
Initial setting: 0

Sound

Karaoke vocal

Enables you to play multi-channel karaoke DVDs. The karaoke channels on the disc will be mixed into normal stereo when you choose [On].

Choices: On, Off
Initial setting: Off

ClearVoice

Increases the relative volume of dialog for easy listening at night. This function is available for only certain multi-channel discs.

Choices: On, Off
Initial setting: Off

Night mode

When set to [On], the dynamics of the sound output is optimized. High volume output is softened, enabling you to watch your favorite action movie without disturbing others.

Choices: On, Off
Initial setting: Off

Toolbar

Program

You can create your own playlist using this menu. First, go to [Tracks], then select the tracks/chapters, etc. to include in your playlist. The programmed playlist will be activated when you choose [On] in the [Program] menu.

Clear all

Deletes all Programmed contents.

Program

Set the FTS program playback on or off.

Choices: On, Off
Initial setting: Off

Tracks

Selects tracks and chapters for your FTS list.

Playlist

Shows the programmed FTS list.

Note:

– For details about FTS and the settings of [Program] menu items, see the descriptions followed by “FTS video/audio program” on page 28.

View

Rotate

Rotates a JPEG image.

Choices: -180° , -90° , 0, $+90^\circ$, $+180^\circ$
Initial setting: 0

Zoom

Activates the zoom function. A cursor will be displayed on screen. Move the cursor using the Δ ∇ \triangleleft \triangleright buttons, then select a size by pressing the ENTER button repeatedly. To exit zoom mode, press RETURN/RESUME repeatedly until the cursor disappears from the screen.

Chapter preview

Plays the first 10 seconds of each chapter/track on the disc. Pressing SCAN on the remote control performs the same function as well.

Choices: On, Off
Initial setting: Off

Angle

Some DVD discs feature a multiple angle function, enabling you to watch certain scenes from various angles. Function availability and the number of camera angles vary according to the disc.

Page

Turns pages of DVD-Audio still images.

Play option

DVD Video Mode

Some DVD-Audio discs include DVD-Video contents that can be played on conventional DVD-Video players. To play such contents, select [On]. The setting returns to [Off] when you eject a disc or turn the unit to standby mode.

Choices: On, Off
Initial setting: Off

Audio

Selects the sound format and audio language. Available choices are determined by the disc.

Disc Navigation

You can direct to a track, etc. by using this menu.

Subtitle

Selects the subtitle language. Available choices are determined by the disc.

Search

Frame by Frame

Advances or reverses one frame at a time. This function is available for video discs only. Previous frame is not available for VCD and SVCD.

Fast

Selects a speed for fast forward or fast reverse playback.

Choices: -32 , -8 , -4 , $+1$, $+4$, $+8$, $+32$
Initial setting: $+1$

Time

You can move to a certain spot by indicating the elapsed time.

Slow

Selects a speed for the slow forward or slow reverse playback.

Choices: -1 , $-1/2$, $-1/4$, $-1/8$, 0, $+1/8$, $+1/4$, $+1/2$, $+1$
Initial setting: 0

Slide Show

Use this feature for JPEG slide show playback.

Picture time

Sets the duration for each image.

Choices: Slow, Medium, Fast

Initial setting: Medium

Setup

Access

Disc lock

This function enables you to restrict others from accessing certain discs.

If this setting is on, you need to enter the four-digit PIN to modify the [Access] menu settings before you can play the disc.

Choices: On, Off

Initial setting: Off

Change PIN

Enables you to change the four-digit PIN.

To change the four-digit PIN, enter the current PIN first, then enter the new four-digit PIN.

Enter PIN

Enter the four-digit PIN to unlock the disc or to display the [Access] menu.

Parental level

DVD movies may contain scenes that are unsuitable for children. Therefore, some discs contain parental control information that may apply to the entire disc or to certain scenes. Ratings are country-specific. You can specify a country code in the On-screen menu (Setup → Language → Country). See “Country” on page 29.

Choices: 0 to 8

Initial setting: 0

Country

Selects a country to apply its rating system to Parental Level control.

Features

PBC

A VCD menu screen is displayed when this setting is on.

Choices: On, Off

Initial setting: On

Sleeptimer

Places this unit in standby mode when playback is stopped and this unit is not operate for 20 minutes.

Choices: On, Off

Initial setting: Off

TV

TV shape

If you connect to a conventional 4:3 aspect TV, select [4:3 panscan] (the left and right sides are trimmed when you play 16:9 video) or [4:3 letterbox] (black areas appear at the top and bottom when you play 16:9 video). Select [Widescreen] if you connect to a Wide-Screen TV.

Choices: 4:3 panscan, 4:3 letterbox, Widescreen

Initial setting: 4:3 panscan

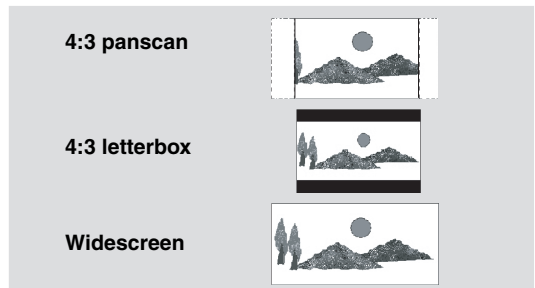

TV System (NTSC/PAL conversion)

Allows you to select [PAL], [NTSC] or [Auto] mode to match your TV system. You can play PAL discs on NTSC monitor, and NTSC discs on PAL monitor. The initial setting is [NTSC].

Choices: PAL, NTSC, Auto

The following conversions are supported.

Disc Format	Output format		
	Selected mode		
	NTSC	PAL	AUTO
NTSC	NTSC	PAL	NTSC
PAL	NTSC	PAL	PAL

Notes:

- In progressive scan mode, the output signals from the VIDEO and S VIDEO jacks are same as the format of the disc you play.
- Some image distortion occurs when switching the NTSC and PAL mode.
- If your TV does not accept the selected mode while you change the [TV System] setting, the screen will be distorted so that you cannot recognize the On-screen menu. When it occurs, you can change the [TV System] settings by the remote control operations. Follow the procedures below.

- Choosing [PAL]:

Press “PLAY” → “2” → “5” → “6” → “PLAY” on the remote control.

- Choosing [NTSC]:

Press “PLAY” → “2” → “5” → “7” → “PLAY” on the remote control.

Do not perform this operation while playing back a disc on this unit.

Audio Menu

Digital output

Enables you to specify the type of digital output that best suits your AV receiver or HDMI monitor/receiver.

Select [PCM only] if your receiver or HDMI monitor/receiver is not capable of decoding multi-channel audio. Select [All] if you connected this unit's digital out jacks to a multi-channel decoder/receiver.

Choices: Off, PCM only, All

Initial setting: All

Note:

- SA-CD audio signal is not output from DIGITAL OUT jacks.

Analog output

Enables you to specify the type of analog output suitable for your AV receiver.

Choices: Stereo, Dolby Surr Compat, 3D sound, Multi-channel

Initial setting: Multi-channel

Stereo: In this setting, the multi-channel audio is downmixed to a stereo signal. Select this setting when connecting to a TV, stereo amplifier/receiver, etc.

Dolby Surr Compat: Select this setting when using equipment with a Dolby Surround Pro Logic decoder. In this setting, the multi-channel audio (Dolby Digital, MPEG-2, DTS) is downmixed to a Dolby Surround compatible 2-ch output. SA-CD and PCM signals with a sampling frequency of over 88.2 kHz are downmixed to normal stereo.

3D sound: In a setup without rear speakers (analogue stereo output), 3D Sound remixes the six channels of digital surround (except for SA-CD and PCM signals with a sampling frequency of over 88.2 kHz) into a two speaker output while retaining all of the original audio information. The result is the sensation of being surrounded by multiple speakers.

Multi-channel: Select this setting when using a multi-channel AV receiver with 6-ch discrete inputs. The multi-channel audio signals those of like DVD-Audio, DVD-Video, and SA-CD are output from the respective 6-ch discrete output jacks. In this mode, this unit will perform DTS decoding, Dolby Digital 5.1-channel decoding, or MPEG Multichannel decoding when applicable, and Dolby Pro Logic II decoding on 2-ch sound tracks except for SA-CD and PCM signals with a sampling frequency of over 88.2 kHz.

PCM output

Enables you to select PCM digital output at 48 kHz or 96 kHz. If you select [48 KHz], PCM data will be converted to 2-ch 48 kHz or less. Select [48 KHz] if the connected equipment cannot process signals with a sampling frequency of 96 kHz or 88.2 kHz.

Choices: 96 KHz, 48 KHz

Initial setting: 96 KHz

Notes:

- Signals are converted to either 48 kHz or 44.1 kHz despite the above settings if the disc has copy protection.
- If you select [96 KHz], signals with a sampling frequency of over 96 kHz are converted to 2-ch 88.2 kHz or 96 kHz.

SA-CD Direct

Enables you (with a suitable speaker system) to bypass the bass management system for multi-channel SA-CD playback, so you can enjoy the pure SA-CD quality.

Choices: On, Off

Initial setting: Off

Note:

- When [SA-CD Direct] is [On], the speaker settings will not be applied during SA-CD playback.

HDMI Audio

If you are not using HDMI audio output, you should set this to [Off].

If the monitor/receiver connected to this unit using HDMI does not support HDMI audio signal input, set this to [Off].

Choices: On, Off

Initial setting: Off

Notes:

- Super Audio CD signals cannot be output using HDMI.
- This unit can output the following audio signals using HDMI: 32/44.1/48 kHz, 2-ch PCM signals and bitstream signals (Dolby Digital, DTS and MPEG). PCM signals with a sampling frequency of over 88.2 kHz are converted to 2-ch 48 kHz or 44.1 kHz.
- When audio signals are being output by a HDMI-component, digital output signals are muted.

Language

Enables you to select a language for audio, subtitles, On-screen menus or DVD menus. The selected languages will be used for all discs, until you modify your settings.
If the selected language is not available on the disc, the default language designated by the disc will be applied.

Default sub-title

Selects a default subtitle language. This setting also applies to DVD menu items.

Menu Language

Selects a language for the On-screen display.

Default Audio

Selects a default audio language.

Speakers

Use this menu to specify speaker size, on/off status, and speaker distance to optimize your listening environment.

Placing all speakers except for the subwoofer at equal distances from the listener is the most ideal way of the speaker positioning in 5.1 channel system. Set the following menu items to create the better listening environment.

You can use the following 8 settings to select the size and layout for your speakers.

Speaker Size / Layout			
Front	Center	Surround	Subwoofer
Large	Large	Large	On
Small	Off	Off	On
Small	Small	Small	On
Large	Off	Off	Off
Large	Small	Small	Off
Large	Off	Small	Off
Large	Small	Off	Off
Large	Small	Small	On

Notes:

- These settings are effective only on analog output signals.
- When playing DVD-Audio with a sampling frequency of over 88.2 kHz, all speaker sizes are set to [Large] and the subwoofer is set [On], regardless of the settings you adjusted.

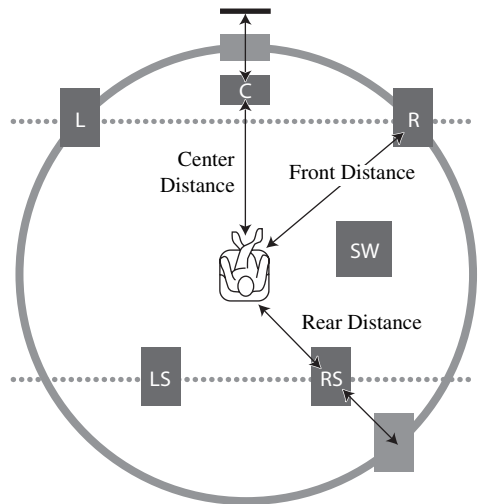

Front Distance

Sets the distance from your listening place to the front speakers. We recommend to place the front left speaker and right speaker at the same distance from the listening point.

Choices: 1 to 12 m
Initial setting: 1.9 m

Center Distance

Sets the distance from your listening place to the center speaker.

Choices: Varies depending on the [Front Distance] setting.
Initial setting: 1.9 m

Note:

- The available range of choice differs depending on the [Front Distance] setting.

Rear Distance

Sets the distance from your listening place to the rear speakers. We recommend to place the rear left speaker and rear right speaker at the same distance from the listening point.

Choices: Varies depending on the [Front Distance] setting.
Initial setting: 1.9 m

Note:

- The available range of choice differs depending on the [Front Distance] setting.

Front Size

Specifies the front speaker size.

Choices: Large, Small
Initial setting: Large

Center Size

Specifies the center speaker size.

Choices: Large, Small, Off
Initial setting: Large

Surround Size

Specifies the surround speaker size.

Choices: Large, Small, Off

Initial setting: Large

Subwoofer

If you wish to use a subwoofer, select [On]. Otherwise select [Off].

Choices: On, Off

Initial setting: On

Note:

- You may not be able to make settings that match your speaker layout.

DVD/CD Mode

Adjusts the volume of each speaker for audio playback (excluding SA-CDs). If you adjust the volume level for any speaker, the volume level for the other speakers is adjusted accordingly.

Front R Vol

Choices: –6 to +6

Initial setting: 0

Front L Vol

Choices: –6 to +6

Initial setting: 0

Center Vol

Choices: –6 to +6

Initial setting: 0

Surround R Vol

Choices: –6 to +6

Initial setting: 0

Surround L Vol

Choices: –6 to +6

Initial setting: 0

Subwoofer Vol

Choices: –6 to +6

Initial setting: 0

SA-CD Mode

You can adjust the volume level output from each channel for SA-CD playback.

You must choose Multi-channel for Analog output to make this function available. (See “Analog output” on page 16.)

If you adjust the volume level for any speaker, the volume level for the other speakers is adjusted accordingly.

Cut-off frequency

Cut off frequency adjustment for a subwoofer.

Choices: 60, 80, 100, 120 (Hz)

Initial setting: 120 (Hz)

Slope

Filter slope adjustment for a subwoofer.

Choices: 12, 18, 24 (dB/oct)

Initial setting: 12 (dB/oct)

Front R Vol

Choices: –6 to +6

Initial setting: 0

Front L Vol

Choices: –6 to +6

Initial setting: 0

Center Vol

Choices: –6 to +6

Initial setting: 0

Surround R Vol

Choices: –6 to +6

Initial setting: 0

Surround L Vol

Choices: –6 to +6

Initial setting: 0

Subwoofer Vol

Choices: –6 to +6

Initial setting: 0

i.LINK

You only need to make this setting if you connected this player to an i.LINK-compatible component. Connected components must be DTCP (Digital Transmission Content Protection)-compliant in order to play DVD audio and Super Audio CD signals received via i.LINK.

Notes:

- This unit supports i.LINK (AUDIO), allowing you to transfer audio signal information to other components compatible with i.LINK (AUDIO). However, because this unit does not support i.LINK (VIDEO), you cannot transfer video information to other components.
- Do not disconnect i.LINK cables or switch off any components connected using i.LINK while this player is turned on.
- Copy-protected 96 kHz DVD-Video discs are downsampled to 48 kHz when using an i.LINK connection.
- You can connect up to 16 i.LINK components to this unit.

Audio Output

Change this setting to [Off] if an i.LINK-compatible component is still connected but you do not want to output signals using i.LINK. Reset to [On] to use the i.LINK interface.

Choices: On, Off

Initial setting: On

Note:

- When audio data is transferred via an i.LINK connection, analog, digital and HDMI audio signals are muted.

Connection Status

This screen shows components connected using the i.LINK interface, and the transfer capabilities of each component with respect to Dolby Digital, DTS and MPEG audio formats.

Choices: Component 1, Component 2, ...
Initial setting: Component 1

Screen Sample

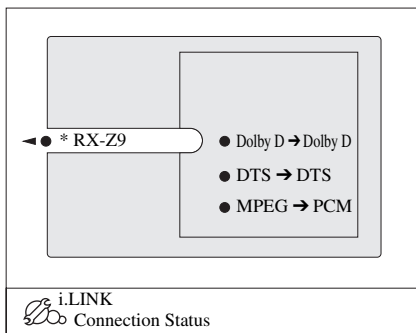

Notes:

- If [PCM] is selected for Digital Output in Setup – Audio Menu, all signals are converted to PCM format before being output.
- An “*” (asterisk) appears next to the name of the component initially recognized by this unit. The audio signal output format is determined by the transfer capabilities of the component, and signals are output to all connected components.
- The component name is displayed only when the i.LINK receiver component connected to this unit supports i.LINK (AUDIO). The component name is not displayed for DVD players or DV camcorders.
- If the i.LINK component connected to this unit does not contain any device name information, “****” is displayed.

AutoPlay Select

You can use this setting to specify a receiver for automatically switching the input to this player when you start playback of a disc.

Choices: Off, Component 1, Component 2, ...
Initial setting: Off

Information about the operational status of this unit is displayed in the front panel display as follows:

Display	Status
BUS FULL	Displayed when data transfer is not possible because you are already using the allowable maximum bandwidth of the i.LINK bus or when 17 or more i.LINK components are connected to this unit.
LINKING	Displayed when this unit is checking a new i.LINK connection.
LOOP CHECK	Displayed when this unit and the i.LINK component are connected in a loop (where the output signal is returned to the original component).
NO OUTPUT	Displayed when an i.LINK connection was activated, but either the new connection is not recognized by DTCP, or the amplifier connected to this unit does not allow transmission.

Note:

- The i.LINK indicator located on the front panel of this unit lights only when i.LINK is selected for an AV amplifier connected to this unit via an i.LINK interface. Even if [Off] is selected for Audio Output in the on-screen menu, the i.LINK indicator lights whenever i.LINK is selected on the connected AV amplifier.

Operation

Notes:

- Unless otherwise stated, all operations described herein are based on remote control usage.
- Some operations can be carried out using the On-screen menu on the TV screen.

Basic playback

- 1 Press STANDBY/ON ⏻ / ⏪ to turn on the unit.
- 2 Press OPEN/CLOSE ⏏ on the front panel to open the disc tray.
- 3 Place the disc in the tray, with the label facing up.
- 4 Press OPEN/CLOSE ⏏ again to close the tray.
 - READING appears in the Status window on TV and on the player's front panel display, and playback starts.
 - If you press PLAY when the tray is open, this unit closes the tray and starts playback.

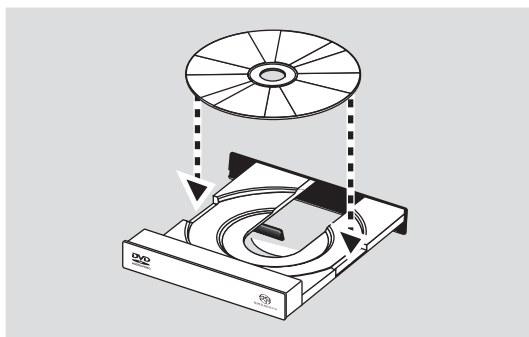

Note:

- If Disc Lock is set to [On] and the disc inserted is not authorized, you must enter a four-digit code (see "Access" on page 15).

DVD-Video and DVD-Audio

- DVD-Video discs may contain one or more titles, and each TITLE may contain one or more chapters.
- DVD-Audio discs may contain one or more groups, and each group may contain one or more tracks.

Disc Structure

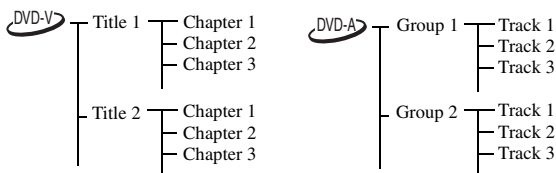

Playing a disc

- 1 Insert the disc and close the tray.
Playback starts automatically.
 - The TV screen and the player's front panel display show the disc type, information and playing time.
- 2 When the Disc Menu appears on the TV screen, use the Δ ∇ \triangleleft \triangleright buttons or the numerical buttons on the remote control to select an option and continue playback.
If the titles are numbered, press the numerical buttons or use the Δ ∇ button to select the desired title in the menu bar.
- 3 To stop playback, press the STOP button.

Smart Resume

This unit memorizes the last five discs and their next starting points where they are stopped at the last time operation.

Using this function, you can quickly return to the scene you were watching last time.

To interrupt playback:

Press STOP to interrupt playback.

Resuming playback of the disc that has **not** been ejected from this unit

- Press PLAY.
 - Playback resumes automatically from the point where the playback was interrupted.
- Press STOP again, then press RETURN/RESUME on the remote control.
 - Playback resumes from the point where the playback was interrupted.
- Press STOP again, then press PLAY.
 - Playback starts from the beginning of the disc.
- Press PLAY when the resume icon is on screen.
 - Playback resumes from the point where the playback was interrupted.

Resuming playback of the disc that has been ejected from this unit

- Re-load the disc.
 - Playback starts from the beginning of the disc.
- Press PLAY when the resume icon is on screen, or press RETURN/RESUME when the playback is not performing.
 - Playback resumes from the point where the playback was interrupted.

Note:

- The Smart Resume function is also compatible with VCDs and SVCDs.

DVD features

Menu

DVDs may contain menus to navigate the disc and access special features such as audio language selection, subtitle language selection, and other options.

- 1 Press MENU.
 - If the disc includes a menu, it will appear on screen.
- To access to the disc menu, press TITLE/CHAP first, then press MENU.
- 2 Press the appropriate numerical buttons or use the $\Delta \nabla \triangleleft \triangleright$ buttons to highlight your selection in the DVD menu, then press the ENTER/OK button to confirm.
- 3 To remove the menu, press MENU again.

Camera angle

Some discs contain scenes that were shot simultaneously from various angles. This unit allows you to select the desired camera angle.

- When this unit encounters a scene shot from multiple angles, it will so indicate in the screen.
 - The angle icon remains displayed until multiple angles are no longer available.
- Press ANGLE repeatedly or use $\Delta \nabla$ buttons to select the desired angle.
 - Playback shifts to the selected angle.
- You can also access the angle function in the On-screen menu (Toolbar → View → Angle).

Changing the audio language and format

- 1 Press AUDIO on the remote control to activate the audio language selection menu.
- 2 Choose a language by pressing the AUDIO button repeatedly or by pressing the $\Delta \nabla$ buttons.
- 3 Press the ENTER/OK button to confirm.

Note:

- You can also select an audio language and an audio format also in the On-screen menu (Toolbar → Play option → Audio).

Subtitle language

- 1 Press SUBTITLE on the remote control to activate the subtitle language selection menu.
- 2 Choose a language by pressing the SUBTITLE button repeatedly or by pressing the $\Delta \nabla$ buttons.
- 3 Press the ENTER/OK button to confirm.

Note:

- You can also select a subtitle language in the On-screen menu (Toolbar → Play option → Subtitle).

DVD-Audio features

The DVD-Audio is developed for the sole purpose of creating high quality pure sound with Linear PCM and Packed PCM (Loss less coding) in up to six audio-channels. The sampling frequency of 192 kHz/24 bits are supported.

Moreover, many DVD-Audio discs offer slide show and page turn capabilities.

When you play a down mix prohibited disc, DOWN MIX indicator turns off. Multi-channel tracks will play regardless of the Analog output settings in the On-screen menu. The MIXED 2CH jacks output the front L and R signals only.

Changing pages

Some DVD-Audio discs contain information pages that can include photo galleries, artist biographies, lyrics, etc.

Every time you press the PAGE button on the remote control, the page is turned to the next.

Playing bonus groups

Some discs contain bonus groups that require a four-digit password to gain access. In this case, consult the disc jacket and other packaging for information.

- 1 While playback is stopped, press TITLE/CHAP button.
 - The group and track list is displayed on the TV screen.
- 2 Press the $\Delta \nabla$ buttons to select a bonus group, then press the \triangleright button.
- 3 Enter a four-digit password using the numeric buttons, then press the ENTER/OK button.
 - To exit from the password entry screen without entering the password, press STOP.
- 4 Press the $\Delta \nabla$ buttons to select a track, then press the ENTER/OK button.

DVD Video Mode

Some DVD-Audio discs include DVD-Video contents that can be played on conventional DVD-Video players. In the On-screen menu (Toolbar → Play option → DVD Video Mode), select [On] to play the DVD-Video content, or select [Off] for normal playback.

Notes:

- The DVD-AUDIO indicator lights up when a DVD-Audio disc is playing.
- When you set DVD-Video mode [ON], the DVD-AUDIO indicator turns off.

SA-CD (Super Audio CD)

The SA-CD standard is based on Direct Stream Digital (DSD) technology. This new direct-stream digital format comprises a 1-bit system that has a digital sampling frequency that is 64 times higher than that of conventional audio CD.

There are three types of SA-CD discs: single-layer, dual-layer and hybrid discs. Each type may contain two areas of recorded information: a High Quality Stereo area and a High Quality Multi-channel area.

- A single layer disc can contain both information areas.
- A dual layer disc can contain both information areas. Double the information can be stored on the disc, thanks to the second layer.
- A hybrid disc can contain both information areas, and also a second, standard CD layer, making it playable on standard CD players.

Recorded information may vary per area, as indicated in the disc inlay. You can select areas before or during playback while you are playing SA-CD via the remote control or via the On-screen display on your TV.

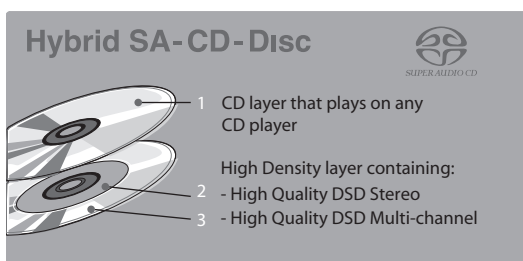
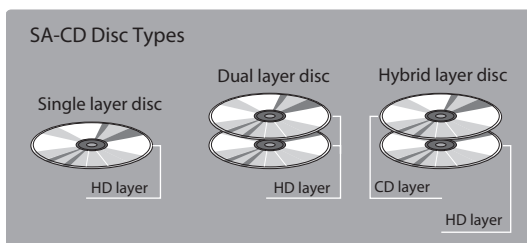

- SA-CD contains only TRACKS.
- Select tracks using the playlist on the screen or by pressing the numerical buttons.
- If SA-CD-text is available on the disc, it will be displayed on the TV screen.

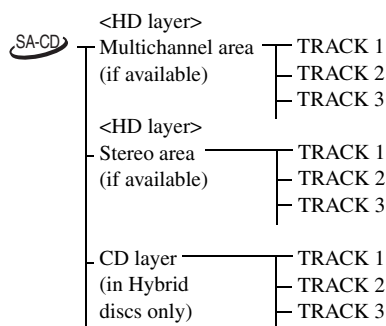

Playing a disc

- 1 Insert the disc and close the tray. Playback starts automatically.
 - The TV screen will display the current playing status and current playing track list in the area.
 - 2 Playback will stop at the end of the disc.
 - 3 To stop playback, press STOP.
- [Analog output] setting in the On-screen menu (Setup → Audio Menu → Analog output) allows you to specify which area of SA-CD to play automatically when you insert the disc. When you select [Stereo], stereo area is selected. When you select the other choices, multi-channel area is selected.
 - If you set the playback area that the disc does not contain, this unit automatically play the available area on the disc.

Sound mode – SA-CD playback

You can change the playback area of the SA-CD by pressing the SOUND MODE button on the remote control.

Press the SOUND MODE at any time to select the multi-channel area or the stereo area in the HD layer. Press the SOUND MODE button when the disc is stopped to select the CD layer.

Select the area by pressing the SOUND MODE button repeatedly.

- On hybrid discs (with SA-CD and CD layers), the player will always start playing the SA-CD layer.
- The SA-CD indicator lights only when the SA-CD layer is selected.
- You can program the playlist in the same area only.

Audio CD

- Audio CDs contain only TRACKS.
- They can be played on this unit with the audio output connected to a stereo system or to your TV.
- Select tracks using the track list on the TV screen or by pressing the numerical buttons or Δ ∇ buttons.

Disc structure

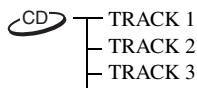

Playing a disc

- 1 Insert the disc and close the tray.
 - Playback starts automatically.
 - The TV screen will display the track list and current playing status.
- 2 Playback will stop at the end of the disc.
- 3 To stop playback, press STOP.

Video CD and Super Video CD

Current VCD 2.0 and Super Video CD 1.0 standard features include:

- Video CDs may contain one or more tracks, and tracks may contain one or more indexes.
- You can display either tracks or indexes.

Disc structure

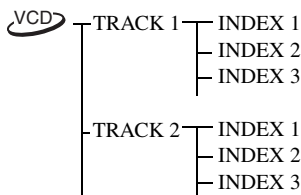

The following VCD and SVCD features and formats are supported:

Features	Video CDs 2.0	Super Video CDs 1.0
Video bit rate resolution NTSC resolution PAL	MPEG-1 constant 1,150 Kbps 352x240, 29.97Hz 352x288, 25Hz	MPEG-2 variable up to 2.6 Mbps 480x480 interlaced, 29.97Hz 480x576 interlaced, 25Hz
Still picture (photo) resolution NTSC resolution PAL	MPEG-1 352x240, 704x480 352x288, 704x576	MPEG-2 (1 Frame) 480x480, 704x480 480x576, 704x576
Audio sampling bit rate audio channels surround sound	MPEG-1 layer II 44.1KHz 224Kbps 1 stereo / 2 mono Stereo with Dolby Pro-Logic	MPEG-1 layer II 44.1KHz 32-384Kbps < 2 stereo / 4 mono MPEG-1 (5+1) extension
Overlay graphics/text sub-channels coding		overlay video plane ≤ 4 4 color CLUT (2bits/pixel)

The following formats are not supported for VCDs:

- HQ-VCD encoded at 2.4Mbps or 2.6Mbps
- XVCD (eXtended VCD) with higher resolution and data rate
- DIVX format files

Playing a disc

- 1 Insert the disc and close the tray.
 - Playback starts automatically.
 - The current track number and its elapsed playing time are displayed in the status window.
- 2 Playback will stop at the end of the disc.
- 3 To stop playback, press STOP.

Notes:

- The Disc Resume feature is also available for VCDs and SVCDs (see the “Smart Resume” section on page 20).
- When you play a Karaoke disc, you can change the vocal by pressing AUDIO on the remote control.

Playback Control (PBC)

Playback Control is a feature on some Video CDs and Super Video CDs that enables users to access selected tracks directly from the disc menu.

- 1 Insert a Video CD or Super Video CD that features PBC, then press PLAY.
- 2 Navigate the menu using the buttons indicated on the TV screen until your chosen passage starts to play. If a PBC menu displays a list of tracks, you can select a track directly.
- 3 Enter your choice using the numerical buttons (0-9).
- 4 Press RETURN/RESUME or \lll to return to the previous menu. Press \ggg to proceed to the next menu.
- 5 You may also select [PBC OFF] in the On-screen menu.
 - When [PBC OFF] is selected, PBC menus are unavailable.

MP3

You can play MP3 music that was recorded onto a CD-R or CD-RW by a computer.

Disc structure (example)

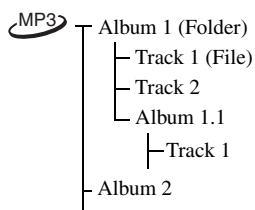

- Since the MP3 format can store several albums onto a disc, a folder is assigned to an “Album”, and a file is assigned to a “Track”.

MP3 disc features

The MP3-CD format (ISO9660 format) support the following:

- MP3 files must have the extension “.MP3” or “.mp3”.
- Max. 30 characters
- Max. nested directory is 8 levels.
- Max. album number is 99.
- Max. track number is 999.
- Supported VBR bit-rate
- Supported sampling frequency of 16/22.05/24/32/44.1/48 kHz

The following features are not supported for MP3 discs:

- The discs that have any types of file other than MP3 and JPEG.
- The simultaneous playback of the MP3 and JPEG files.
- Chinese filenames and text
- Non-finalized closed discs
- Discs recorded in UDF format

Additional note for MP3 disc playback:

- The disc read time may exceed 10 seconds due to the large number of songs compiled onto one disc.
- Multi-session discs are supported.
- The digital output signals of MP3 files are copy-protected.

Downloading MP3 files from the internet or copying songs from your own legal discs is a delicate process.

Playing a disc

- 1 Insert the disc and close the tray.
→ Playback starts and the playlist appears automatically. If the disc includes both MP3 and JPEG files, the selection menu appears on the screen and asks you which file to play.
- 2 Playback will stop at the end of the disc.
- 3 To stop playback, press STOP.

Choosing an Album/Track to playback

You can choose an Album/Track to playback from the list displayed in the TV screen.

- 1 In the playlist, press Δ ∇ to select the Album/Track to playback.
- 2 Press \triangleleft \triangleright to select the Album/Track in the next layer to playback.

MP3 text

MP3-CD discs may contain text information called ID3 Tag (e.g., track name, album name, artist name, etc.) that can appear on the TV screen during playback.

JPEG

This player can playback JPEG format pictures on a personally recorded CD-R/RW disc or commercial CD.

Disc structure

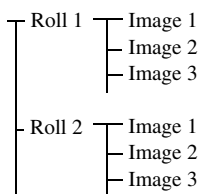

JPEG disc features

The JPEG format (ISO 9660 format) supports the following:

- Max nested directories, 8 levels.
- Max numbers of rolls are 99.
- Max numbers of pictures are 999.
- The files with the extensions of “.JPEG”, “.jpeg”, “.JPG”, or “.jpg”.

The following types of disc and conditions are not supported:

- Discs with playback control functions
- The discs that have any types of file other than MP3 and JPEG
- The simultaneous playback of the JPEG and MP3 files
- Progressive JPEG formatted discs
- Non-finalized discs
- UDF formatted discs

Notes:

- The disc read time may exceed 10 seconds if the disc has large amount of pictures. The read time may vary depending on the file types and sizes.
- Multi-session discs are supported.

Playing a disc

- 1 Insert the disc and close the tray.
 - Playback starts automatically.
 - Thumbnails are displayed on screen.

A chosen thumbnail can be displayed on full screen. Move the cursor with $\Delta \nabla \triangleleft \triangleright$ to select the thumbnail, and press ENTER/OK. Press MENU to return to the thumbnail screen.
- 2 Press PLAY during a full screen mode.
 - The slide show starts.
- 3 To stop playback, press STOP.
 - The slide show stops.

- Press MENU to return to the thumbnail screen.
- When you press PAUSE, the slide show pauses. To return to the normal slide show, press PLAY.
- Repeat and shuffle function are also available for JPEG discs.

Slide show setting

You can set the duration of each image.

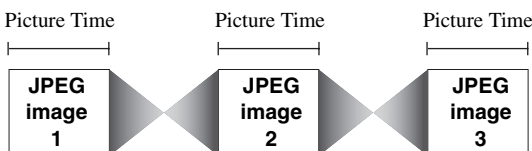

Picture Time

- 1 Press ON SCREEN.
 - The On-screen menu appears.
 - 2 Go to [Picture Time] (Toolbar → Slide Show → Picture time) by using $\Delta \nabla \triangleleft \triangleright$ buttons, then press \triangleright .
 - 3 Make a choice with $\Delta \nabla$.
 - Choices: Slow (about 8 sec), Medium (about 5 sec), Fast (about 2 sec)
 - 4 To return to the previous menu, press \triangleleft .
- To exit from the On-screen menu, press ON SCREEN.

Rotating the image

You can rotate the JPEG image.

- 1 Press ON SCREEN.
 - The On-screen menu appears on the screen.
 - 2 Go to [Rotate] (Toolbar → View → Rotate) by using $\Delta \nabla \triangleleft \triangleright$ buttons, then press \triangleright .
 - 3 Make a choice with $\triangleleft \triangleright$.
 - Choices: -180, -90, 0, +90, +180
 - 4 To return to the previous menu, press \triangleleft .
- To exit from the On-screen menu, press ON SCREEN.

Note:

- This function is not available during slide show playback.

General features

Moving to another segment

When a disc includes more than one segment, you can quickly move to another segment by the following operation.

Moving to the appointed segment directly:

- 1 Press TITLE/CHAP button on the remote control.
→ The TITLE/CHAP menu appears on the screen.
- 2 Press Δ ∇ or the numerical buttons to select a segment. Press RETURN/RESUME button on the remote control to erase the TITLE/CHAP menu from the screen.

Moving to the next/previous segment:

Press $\triangleright\triangleright$ or $\triangleleft\triangleleft$ briefly during playback to proceed to the next segment or to return to the beginning of the current segment.

Press $\triangleleft\triangleleft$ twice quickly to step back to the previous segment.

Numeric button operation:

For the direct access to a segment, enter the segment number using the numerical buttons (0-9) on the remote control.

For example to select the segment number 12, press 1 first, then press 2.

Search

Key control:

To search forward or reverse at various speeds, hold down $\triangleright\triangleright$ or $\triangleleft\triangleleft$ for more than two seconds. The choices are for audio discs, -8, -4, +4, +8; and for video discs, -32, -4, +4, +32.

OSD control:

- 1 Select [Fast] in the On-screen menu (Toolbar → Search → Fast).
- 2 Press the $\triangleleft\triangleright$ button to select the desired speed.
- 3 Select [+1] to resume playback at normal speed.

Slow motion

OSD control:

- 1 Select [Slow] in the On-screen menu (Toolbar → Search → Slow), then press \triangleright .
→ Playback pauses.
- 2 Press $\triangleleft\triangleright$ to select the desired speed: -1, -1/2, -1/4 or -1/8 (reverse), or +1/8, +1/4, +1/2 or +1 (forward).

- 3 Select [+1] to resume playback at normal speed.
- 4 If you press the \square button, the speed will be set to zero (PAUSE).
- 5 To exit slow motion mode, press PLAY.

Notes:

- You can use this function for DVD-Audio while the disc is playing its video content.
- Slow motion in reverse is not available for VCDs or SVCDs.

Still picture and frame-by-frame playback

Key control:

You can activate frame-by-frame playback by pressing the PAUSE repeatedly.

OSD control:

- 1 Select [Frame by Frame] in the On-screen menu (Toolbar → Search → Frame by Frame), then press \triangleright .
→ Playback pauses.
- 2 Press the $\triangleleft\triangleright$ button to select the previous or next picture frame.
- 3 To exit frame-by-frame playback, press PLAY.

Note:

- You can use this function for DVD-Audio while the disc is playing its video content.

Time search

The Time Search function enables you to start playback at a specific time on the disc.

- 1 Select [Time] in the On-screen menu (Toolbar → Search → Time).
→ Playback pauses.
→ The elapsed playing time is displayed in a time edit window.
- 2 Enter hours, minutes and seconds from left to right in the time edit window using the remote control numerical buttons.
→ Each time an item is entered, the next item is highlighted.
- 3 Press the ENTER/OK button to confirm the selected time.
→ Playback starts from the selected time position on the disc.
- 4 Press ON SCREEN to remove the menu bar.

Repeat

Press REPEAT button to repeat a certain segment of the disc.

Each time you press REPEAT, the repeat mode changes as follows:

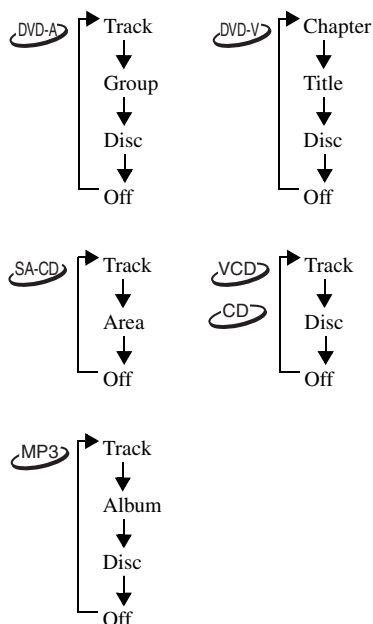

This feature may not be available on some discs.

Repeat A-B

DVD-A **SA-CD** **VCD** **CD** **MP3**

Repeat a sequence in a track.

DVD-V

Repeat a sequence in a title.

- 1 Press A-B at the desired starting point.
→ REPEAT A- is displayed on the front panel display.
- 2 Press A-B again at the desired end point.
→ REPEAT A-B appears briefly on the front panel display, and the repeat sequence begins.
- 3 To exit the sequence, press A-B.
→ REPEAT OFF is displayed on the front panel display.

Shuffle

DVD-A **DVD-V** **MP3**

This function shuffles the playing order of chapters or tracks within a title/group/album (if the title/group/album has more than one chapter or track). When Shuffle Play within a title/group/album finishes, the unit continues shuffle playback within the next title/group/album.

- 1 Press SHUFFLE during playback.
→ SHUFFLE appears on the screen for about two seconds.
- 2 To return to normal playback, press SHUFFLE again.

SA-CD **VCD** **CD**

This function shuffles the playing order of tracks on a disc.

- 1 Press SHUFFLE during playback.
→ SHUFFLE appears on the screen for about two seconds.
- 2 To return to normal playback, press SHUFFLE again.

Note:

- For SA-CD this function works in the currently selected area only.

Scan **DVD-A** **DVD-V** **SA-CD** **VCD** **CD** **MP3**

Plays the first 10 seconds of each segment on the disc.

- 1 Press SCAN.
- 2 To continue playback at your chosen segment, press SCAN again or press PLAY.

Note:

- You can also access this function by selecting [Chapter Preview] in the On-screen menu.

Zoom **DVD-A** **DVD-V** **VCD**

This function allows you to enlarge the video image and pan through the enlarged image during playback or pause.

- 1 Press ZOOM on the remote control, or select [Zoom] in the On-screen menu (Toolbar → View → Zoom) and press \triangleright to enter zoom mode.
→ The cursor appears on screen.
- 2 Press the Δ ∇ \triangleleft \triangleright buttons to move around the image on screen.
- 3 Press the ENTER/OK button to enlarge the image. Each time you press the ENTER/OK button, the zoom factor changes from x1 to x2 to x4 to x8.
- 4 To exit from zoom mode, press ENTER/OK repeatedly to select x1. Then, press the ZOOM button in order to turn off the cursor from the screen.

FTS video/audio program



- The FTS (Favorite Track Selection) function enables you to store your favorite tracks, etc.
 - The FTS list can contain up to 20 items.
 - The most recent program list is placed on the top of the existing list.
- 1 Press ON SCREEN on the remote control.
→ The On-screen menu appears.
 - 2 Go to [Tracks] (Toolbar → Program → Tracks) by using the $\Delta \nabla \triangleleft \triangleright$ buttons, then press the \triangleright button.
 - 3 Press the $\Delta \nabla$ button to select the item to store in your FTS list, then press the ENTER/OK.
→ The selected item flashes momentarily when it is stored in the FTS list.
 - 4 Repeat the above procedure to set the FTS list.
 - 5 Press the \triangleleft button, then press ON SCREEN to exit from the On-screen menu.
→ This unit starts playing the FTS list automatically.

Notes:

- You can check your FTS list in the On-screen menu (Toolbar → Program → Playlist). Press the $\Delta \nabla$ buttons to navigate the playlist menu.
- For SA-CD, you can program FTS list in the currently selected area only.
- For DVD-Audio, the password must have been entered in order to play bonus tracks.

Activating/deactivating the FTS program

You need to select [On] in the [Program] menu to activate the FTS function.

- 1 Press ON SCREEN on the remote control.
→ The On-screen menu appears.
- 2 Go to [Program] (Toolbar → Program → Program) by using the $\Delta \nabla \triangleleft \triangleright$ buttons, then press the \triangleright button.
- 3 Press the $\Delta \nabla$ to select [On] or [Off].
- 4 Press the \triangleleft button, then press ON SCREEN to exit from the On-screen menu.

Erasing a track/chapter/index from the FTS list

You can erase the items that you programmed in the FTS list.

- 1 Press ON SCREEN on the remote control
→ The On-screen menu appears.
- 2 Go to [Playlist] (Toolbar → Program → Playlist) by using the $\Delta \nabla \triangleleft \triangleright$ buttons, then press the \triangleright button.
- 3 Press the $\Delta \nabla$ button to select the item you want to erase, then press ENTER/OK.
→ The selected item disappears from the list.
- 4 Press the \triangleleft button, then press ON SCREEN to exit from the On-screen menu.

Erasing all tracks/chapters/indexes from the FTS list

You can erase everything at once in the FTS list.

- 1 Press ON SCREEN on the remote control.
→ The On-screen menu appears.
- 2 Go to [Clear all] (Toolbar → Program → Clear all) by using the $\Delta \nabla \triangleleft \triangleright$ buttons, then press the \triangleright button.
→ “Cleared” appears momentarily, then all items in the list are erased.
- 3 Press the \triangleleft button, then press ON SCREEN to exit from the On-screen menu.

Disc lock

Activating/deactivating Disc lock

Using this function you can prohibit the access of others to certain discs.

- 1 Press ON SCREEN on the remote control.
The On-screen menu appears.
- 2 Go to [Enter PIN] (Setup → Access → Enter PIN) using the $\Delta \nabla \triangleleft \triangleright$ buttons, then press the \triangleright button.
- 3 Enter the four-digit PIN of your own choosing.
- 4 Move to [Disc lock] menu using the $\Delta \nabla$ buttons.
- 5 Select [On] or [Off] using the $\Delta \nabla$ buttons.
- 6 Press the \triangleleft button, then press ON SCREEN to exit the On-screen menu.
→ If you select [On] in the [Disc lock] menu, unauthorized discs will not be played unless the four-digit PIN is entered.

Notes:

- Confirmation of the four-digit PIN is necessary when:
 - The PIN is entered for the very first time (see above).
 - The PIN is changed or cancelled (see “Changing the four-digit PIN” on page 29).
- If you select [Off] in the [Disc lock] menu, the FTS function will not be performed.

Authorizing discs

When [Disc lock] is [ON], you must authorize discs before you can play them.



- 1 Insert the disc.
The Disc lock dialog will appear.
 - 2 Enter your four digit PIN for [Play once] or [Play always].
- If you enter the four-digit PIN for [Play Once], the disc can be played one time only. You must re-enter the code if disc is ejected or the power is turned off.
 - If you enter the four-digit PIN for [Play always], the disc can be played anytime, even when [Disc lock] is [ON].

Notes:

- The player memory can maintain 120 authorized (Disc locked) disc titles. A disc title will be added to the list if [Play always] is selected.
- Each time a Disc locked disc is played, it will be added to the top of the list. When the list is full (120), the last disc in the list will be replaced when a new disc is added.
- Double-sided DVDs and multi-volume VCDs may have a different ID for each side. In order to make Disc Locks to such discs, each side must be authorized.

Deauthorizing discs

If you authorize a disc for [Play always], the disc content will always be available for playback — until you deauthorize the disc. Follow the procedure below to deauthorize a disc.

- 1 Insert the disc.
→ Playback starts automatically.
- 2 Press STOP within about 10 seconds after  appears in the screen.
→  will appear on the screen, indicating that the disc is now locked.

Parental Control

DVD movies may contain scenes that are unsuitable for children. Therefore, discs may contain Parental Control information that may apply to the entire disc or to certain scenes. These scenes are rated from 1 through 8. Alternative, more suitable scenes may be available on the disc. Ratings are country-specific. The Parental Control feature enables you to prevent discs from being played by your children or, in some cases, to substitute alternative scenes.

Activating/deactivating Parental Control

- 1 When the disc playback is stopped, press ON SCREEN on the remote control.
→ The On-screen menu appears.
- 2 Go to [Enter PIN] (Setup → Access → Enter PIN) by using the $\Delta \nabla \triangleleft \triangleright$ buttons, then press the \triangleright button.
- 3 Enter your four-digit PIN.
- 4 Press the $\Delta \nabla$ button to select [Parental level], then press the \triangleright button.
- 5 Press the $\triangleleft \triangleright$ button to select a rating from 1 through 8 for the disc.

Rating 0:

Parental Control is not active. The disc plays in full.

Ratings 1 to 8:

If you set a rating for the player, all scenes with the same rating or lower will be played. Higher rated scenes will not be played unless an alternative that has the same rating or lower is available on the disc. If no suitable alternative is available, playback will stop and the four-digit code will be required to proceed.

- 6 Press the ENTER/OK button, then press the ON SCREEN button to exit the On-screen menu.

Country

You can apply a rating system associated with a specific country to the Parental Level control.

- 1 When the disc playback is stopped, press ON SCREEN on the remote control.
→ The On-screen menu appears.
- 2 Go to [Enter PIN] (Setup → Access → Enter PIN) by using the $\Delta \nabla \triangleleft \triangleright$ buttons, then press the \triangleright button.
- 3 Enter your four-digit PIN.
- 4 Press the $\Delta \nabla$ button to select [Country], then press the \triangleright button.
- 5 Select a country using the $\Delta \nabla$ button.
- 6 Press the ENTER/OK button to confirm your selection and exit.

Changing the four-digit PIN

- 1 When the disc playback is stopped, press ON SCREEN on the remote control.
→ The On-screen menu appears.
- 2 Go to [Enter PIN] (Setup → Access → Enter PIN) by using the $\Delta \nabla \triangleleft \triangleright$ buttons, then press the \triangleright button.
- 3 Enter the current four-digit PIN.
- 4 Press the Δ button to highlight [Change PIN], then press the \triangleright button.
- 5 Enter the current four-digit PIN again, then enter a new four-digit PIN.
- 6 Enter the new PIN again.
- 7 Press the ON SCREEN button to exit the menu.
→ The new four-digit code is in effect.

If you forget your four-digit code

- 1 Press \triangle OPEN/CLOSE to remove the disc, then press \triangle OPEN/CLOSE again to close the tray.
- 2 Press ON SCREEN on the remote control.
→ The On-screen menu appears.
- 3 Go to [Enter PIN] (Setup → Access → Enter PIN) by using the $\Delta \nabla \triangleleft \triangleright$ buttons, then press the \triangleright button.
- 4 Press the \square button for four times.
→ “Enter New PIN” appears on screen.
- 5 Enter your new four-digit PIN.

Note:

- The factory default PIN is 0000.

Troubleshooting

WARNING

Under no circumstances should you try to repair the system yourself, as this will invalidate the warranty. Do not open the system as there is a risk of electric shock.

If a fault occurs, first check the points listed below before taking the system in for repair.

Problem	Solution
No power	<ul style="list-style-type: none">– Check to ensure that the AC power cord is properly connected.
No picture	<ul style="list-style-type: none">– Check to ensure that the TV is switched on.– Check the video connection.
Distorted picture	<ul style="list-style-type: none">– Occasionally, a small amount of image distortion may be visible. This is not a malfunction.
Completely distorted picture or black and white picture when playing a DVD/ Super Audio CD or Video CD	<ul style="list-style-type: none">– Make sure the NTSC/PAL setting on the DVD player matches the video signal of your television. (See “TV System (NTSC/PAL conversion)” on page 15.)
No sound or distorted sound	<ul style="list-style-type: none">– Adjust the volume.– Check that the speakers are connected correctly.
No audio at digital output	<ul style="list-style-type: none">– Check the digital connections.– Check the settings menu to ensure that the digital output is set to [All] or [PCM only].– Check to ensure that the audio format of the selected audio language matches your receiver capabilities.
Disc does not play.	<ul style="list-style-type: none">– Check that the disc label is facing up.– Determine if the disc is defective by trying another disc.
Picture freezes momentarily during playback.	<ul style="list-style-type: none">– Check the disc for fingerprints or scratches.– Clean with a soft cloth, wiping from center to outside edge.
Fails to return to start-up screen when disc is removed	<ul style="list-style-type: none">– Reset the unit by switching the player off, then on again.
No response to remote control	<ul style="list-style-type: none">– Aim the remote control directly at the sensor on the front of the player.– Reduce the distance to the player.– Replace the batteries in the remote control.– Re-insert the batteries with their polarities (+/- signs) as indicated.
Buttons do not work or player stops responding.	<ul style="list-style-type: none">– To completely reset the player, unplug the AC cord from the AC outlet for 5-10 seconds.
No response to some operating commands during playback	<ul style="list-style-type: none">– Certain operations may not be permitted by the disc. Refer to the instructions for the disc.
Cannot read CDs/DVDs	<ul style="list-style-type: none">– Use a cleaning CD/DVD to clean the lens before sending this unit in for repair.
The picture is not displayed in a proper position on the screen	<ul style="list-style-type: none">– Change the parameter of the Video Shift menu in the On-screen menu (Preferences → Picture → Video shift). See page 12, 13.
Connect record MP3	<ul style="list-style-type: none">– SCMS copy protected discs cannot be recorded digitally. Try recording by analog jacks.

If the problem is not listed above, or if the instructions fail to help, turn off the power to the unit, disconnect the power cable, and contact the nearest authorized YAMAHA dealer or service center.

Specifications

PLAYBACK SYSTEM

DVD-Audio
DVD-Video
Super Audio-CD, Stereo/Multi-channel and Hybrid disc
DVD+R, DVD+RW
DVD-R, DVD-RW (Video Format)
Video CD (VCD)
Super Video CD (SVCD)
CD-Audio (CD-DA)
CD-R/CD-RW (CD-DA, VCD, SVCD)
MP3, JPEG

TV STANDARD (PAL/50 Hz) (NTSC/60 Hz)

Number of lines	625	525
Playback	Multistandard	(PAL/NTSC)

VIDEO PERFORMANCE

YUV output	Y: 1Vpp into 75 ohm Pb/Cb Pr/Cr: 0.7Vpp into 75 ohm
S-Video output	Y: 1Vpp into 75 ohm C: 0.3Vpp into 75 ohm (PAL) C: 0.286Vpp into 75 ohm (NTSC)
Video output	1 Vpp into 75 ohm

AUDIO FORMAT

DSD	Multi-channel and Stereo
Dolby Digital/DTS/MPEG	Compressed Digital
PCM/Packed PCM	fs 48, 96, 192, and 44.1, 88.2, 176.4kHz 16, 20, 24bits
MP3 (ISO9660)	32, 44.1, 48, and 16, 22.05, 24kHz

Full decoding of Dolby Digital, DTS and MPEG multi-channel sound/analogue stereo sound
Dolby Surround compatible downmix from Dolby Digital multi-channel sound
3D Sound for virtual 5.1 channel sound on two speakers
Dolby Pro Logic II 5.1 ch decoding from the stereo source

SA-CD AUDIO PERFORMANCE

D/A Converter	DSD
SA-CD	fs 2.8224 MHz
Max. output voltage (0 dB)	2 V rms
Signal-Noise Ratio	115 dB
Dynamic Range	107 dB
Total Harmonic Distortion (1 kHz)	0.0017 %

AUDIO PERFORMANCE (Without upsampling)

DA Converter	24 bits	
DVD	fs 96 kHz	2 Hz - 44 kHz
CD/Video CD	fs 44.1 kHz	2 Hz - 20 kHz
Signal-Noise Ratio		115 dB
Dynamic Range		103 dB
		(DVD 48 kHz 24 bit)
Total Harmonic Distortion (1 kHz)		0.0017 %
		(DVD 48 kHz 24 bit)

CONNECTIONS

SCART	Euroconnector x1 (Europe model only)
Y Pb/Cb Pr/Cr	Cinch 3x (green, blue, red)
S-Video Output	Mini DIN, 4 pins
Video Output	Cinch (yellow) x1
Audio Mixed 2 ch Output	Cinch (white/red)
Digital Output	1 coaxial, 1 optical
6 channel analogue output	
Audio Main L/R	Cinch (white/red)
Audio Surround L/R	Cinch (white/red)
Audio Centre	Cinch (blue)
Audio Subwoofer	Cinch (black)
HDMI	TYPE A x1
IEEE1394	4 pins x2

CABINET

Dimensions (w x h x d)	435 x 100 x 314 mm
Weight	Approx. 5.6 kg

POWER SUPPLY

Power inlet	
U.S.A and Canada models	AC120V, 60 Hz
Australia model	AC240V, 50 Hz
U.K. and Europe models	AC230V, 50 Hz
General model	AC110-240V, 50/60 Hz
Power usage	Approx. 33 W
Power usage standby	< 1 W

Specifications subject to change without notice.



© 2005 YAMAHA CORPORATION All rights reserved.

YAMAHA ELECTRONICS CORPORATION, USA 6660 ORANGETHORPE AVE., BUENA PARK, CALIF. 90620, U.S.A.
YAMAHA CANADA MUSIC LTD. 135 MILNER AVE., SCARBOROUGH, ONTARIO M1S 3R1, CANADA
YAMAHA ELECTRONIK EUROPA G.m.b.H. SIEMENSSTR. 22-34, 25462 RELINGEN BEI HAMBURG, GERMANY
YAMAHA ELECTRONIQUE FRANCE S.A. RUE AMBROISE CROIZAT BP70 CROISSY-BEAUBOURG 77312 MARNE-LA-VALLEE CEDEX02. FRANCE
YAMAHA ELECTRONICS (UK) LTD. YAMAHA HOUSE, 200 RICKMANSWORTH ROAD WATFORD, HERTS WD18 7GQ, ENGLAND
YAMAHA SCANDINAVIA A.B. J A WETTERGRENS GATA 1, BOX 30053, 400 43 VÄSTRA FRÖLUNDA, SWEDEN
YAMAHA MUSIC AUSTRALIA PTY, LTD. 17-33 MARKET ST., SOUTH MELBOURNE, 3205 VIC., AUSTRALIA

YAMAHA CORPORATION
Printed in China © 3139 246 13392